



# Panasonic<sup>®</sup>

## Reference Manual

Personal Computer

---

Model No. **CF-52 Series**

---







We recommend that this Reference Manual be printed.

## NOTE

- Do not repeatedly press the keys in quick succession.
- Do not use the key combinations together with touch pad (external mouse) or other key operations.
- Do not use the key combinations before you log on to Windows. Wait until the hard disk drive indicator  turns off. On the Setup Utility screen, you can use the key combinations of **Fn+F1**, **Fn+F2** and **Fn+F3**. By using the key combinations of **Fn+F3**, the display is switched between the internal LCD, simultaneous display<sup>\*1</sup> and the external display.
- The key combinations may not work with some applications.
- The popup menu icon appears after logging on to Windows. It may not appear in some application conditions (e.g., when [Command Prompt] is set to “Full Screen”).

\*1 Only for model with Mobile Intel® PM965 Express Chipsets

Key	Function	Popup menu icon
<b>Fn+F1</b> <b>Fn+F2</b>	<b>LCD brightness</b> ( <b>Fn+F1</b> = down / <b>Fn+F2</b> = up)	
<b>Fn+F3</b>	<b>Display switching</b> (→ page 45) (When an external display is connected) Internal LCD → Simultaneous display → External display ↑ <b>CAUTION</b> <ul style="list-style-type: none"> <li>● Do not press any keys until the display has finished switching.</li> <li>● Do not use this function: <ul style="list-style-type: none"> <li>• When an external display is not connected.</li> <li>• When playing motion video such as DVD or MPEG.</li> <li>• When using the Extended Desktop.</li> <li>• When showing a game screen such as pinball.</li> </ul> </li> </ul>	—
<b>Fn+F4</b>	<b>Speaker on/off</b> <b>NOTE</b> <ul style="list-style-type: none"> <li>● Beeps do not sound if you turn off the speaker sound.</li> </ul>	 OFF (MUTE)  ON

Key	Function	Popup menu icon
<b><u>Fn</u>+<u>F5</u></b> <b><u>Fn</u>+<u>F6</u></b>	<p><b>Volume</b> (<b><u>Fn</u>+<u>F5</u></b>= down / <b><u>Fn</u>+<u>F6</u></b>= up)</p> <p><b>NOTE</b></p> <ul style="list-style-type: none"> <li>• When fine-tuning the sound volume, press and hold <b><u>Fn</u></b>, and press <b><u>F5</u></b> or <b><u>F6</u></b> intermittently.</li> <li>• This does not work on beeps or speakers connected to the USB port.</li> </ul>	
<b><u>Fn</u>+<u>F7</u></b>	Activate standby (→ page 6)	—
<b><u>Fn</u>+<u>F9</u></b>	Remaining battery level (When the battery pack is inserted in the computer)	→ page 12
<b><u>Fn</u>+<u>F10</u></b>	Activate hibernation (→ page 6)	—

## Hotkey Settings

You can make two settings:

- **Fn key lock**  
**Fn** is locked (pressed-down) until you press another key. Use this when pressing difficult key combinations.
- **Popup menu icon on/off**

### 1 Start up the Hotkey Settings.

Click [start] - [All Programs] - [Panasonic] - [Hotkey Settings].

### 2 Make the settings.



#### [Use Fn key lock]

- When using an **Fn** key combination
  - ① Press **Fn** once. (Locked)
  - ② Press another key. (Lock released)
- When using successive **Fn** key combinations
  - ① Press **Fn** twice. (Locked)
  - ② Press another key.  
Fn key remains locked until you press **Fn** again.

#### [Notification]

[Make sounds when Fn key is pressed]<sup>\*2</sup>

[Show status on screen]: Displays the Fn key status on the notification area.

- : **Fn** is locked.
- : **Fn** is not locked.

#### [Disable popup]

The popup menu icon will not be displayed.

### 3 Click [OK].

#### NOTE

- You can have different settings for each user.

<sup>\*2</sup> If the speakers are muted, beeps do not sound.

The standby/hibernation functions allow you to shut off the computer without closing programs and documents. You can quickly return to the programs and documents that you were working on before standby or hibernation.

Function	Data is saved to	Recovery time	Power supply
Standby	Memory	Short	Required. (If power is not supplied, all data will be lost.)
Hibernation	Hard disk	Rather long	Not required. (However power is slightly consumed to keep the hibernation.)

## Setting Standby or Hibernation

- 1 Click [start] - [Control Panel] - [Performance and Maintenance] - [Power Options] - [Advanced].
- 2 Select [Stand by] or [Hibernate] for [When I close the lid of my portable computer:] / [When I press the power button on my computer:], and then click [OK].

### NOTE

- You do not need to make the setting if you use the Windows menu to enter standby or hibernation.

## Precautions

- Connect the AC adaptor if the computer will be in standby mode for a long period of time. If you cannot use the AC adaptor, use hibernation instead.
- Using standby or hibernation repeatedly may cause malfunction of the computer. To stabilize computer operation, restart Windows regularly (about once a week) without using standby or hibernation.
- Save the necessary data.
- Close files you have opened from removable disk and network drive.
- The password you set in the Setup Utility is not requested at resuming. You can use the Windows password for security in standby or hibernation.
  - ① Click [start] - [Control Panel] - [User Accounts], and select the account.
  - ② Click [Create a password] and set the password.
  - ③ Click [start] - [Control Panel] - [Performance and Maintenance] - [Power Options] - [Advanced], and add the check mark in [Prompt for password when computer resumes from standby].

- Do not enter standby or hibernation in the following conditions, otherwise the data or file may be corrupted, standby/hibernation may not work, or malfunction may occur in the computer or the peripheral devices.
  - When any of the multimedia pocket device indicator (MP), the hard disk drive indicator (HDD) and the SD Memory Card indicator (SD) is on.
  - When playing/recording audio files or displaying motion video such as MPEG files.
  - When playing a DVD-Video.
  - When writing to a disk.
  - When using communication software or network function.
  - When using a PC Card.  
(If the card fails to work normally, restart the computer.)
  - When an external mouse is connected to the serial port.
- If a disc formatted with B's CLiP is inserted into the CD/DVD drive (while  is displayed on the notification area), the computer cannot enter standby or hibernation. Eject the disc beforehand.
- The computer does not enter standby or hibernation immediately after resuming. Wait approximately one minute.

## Entering/Resuming from Standby or Hibernation

### ■ To enter standby or hibernation

- 1 **Close the display, or press the power switch (A) until a beep<sup>\*1</sup> sounds.**

Standby: The power indicator (B) blinks green.

Hibernation: The power indicator (B) goes off.

- You can alternatively use the Windows menu to enter standby or hibernation. To enter standby, click [start] - [Turn Off Computer] - [Stand By]. To enter hibernation, click [start] - [Turn Off Computer], then press and hold **Shift** and click [Hibernate].

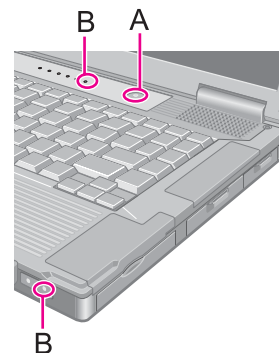

### CAUTION

#### While the computer is entering standby or hibernation

- Do not:
    - Touch the keyboard, touch pad, or power switch.
    - Use an external mouse or other peripheral device.
    - Connect or disconnect the AC adaptor.
    - Close or open the display.
- Wait until the power indicator blinks green (standby) or goes off (hibernation).
- It may take one or two minutes to enter standby or hibernation.

- At the beep<sup>\*1</sup>, immediately release the power switch. If you press and hold the power switch for longer than four seconds, the computer will forcibly shut down and unsaved data will be lost even if you have set [Shut down] in [When I press the power button on my computer:] (→ page 5 “Setting Standby or Hibernation”).

\*1 If the speakers are muted, beeps do not sound.

## In standby or hibernation mode

- Do not attach or remove a multimedia pocket device and peripheral device. Doing so may cause malfunction.
- Power is consumed in standby mode. Power consumption may increase when a PC Card is inserted. When power is exhausted, the data retained in memory will be lost. Connect the AC adaptor when using the standby function.
- Do not turn on/off the wireless switch.

## ■ To resume from standby or hibernation

### 1 Open the display, or press the power switch (A).

- When [Stand by] or [Hibernate] is selected as the setting for [When I close the lid of my portable computer:] (→ page 5), you can resume operation opening the display.

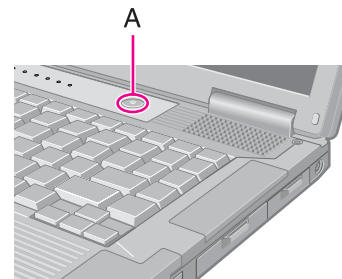

## CAUTION

- Do not perform the following operations until resuming is complete. After the display is resumed, wait approximately 15 seconds (normally) or 60 seconds (when the computer is on a network).
  - Touch the keyboard (except for password input), touch pad, or power switch.
  - Use an external mouse or other peripheral device.
  - Connect or disconnect the AC adaptor.
  - Close or open the display.
  - Shut down or restart Windows.
  - Enter standby or hibernation.
  - Turn on/off the wireless switch.

Use these features to protect your data.

- Other security measures
  - SD Security (→ [page 37](#))
  - Embedded Security (TPM) (→ [page 67](#)): For further information, refer to the *Installation Manual* of “Trusted Platform Module (TPM)”.

## Setting the Supervisor Password/User Password

Set the Supervisor Password before setting the User Password.

- 1 Start up the Setup Utility (→ [page 63](#)).**
- 2 Select [Security].**
- 3 Select [Set Supervisor Password] or [Set User Password], and press Enter.**
- 4 Enter your password in [Enter New Password] and press Enter.**
  - When the password has been set, you need to enter your password in [Enter Current Password] and press Enter.
  - To disable the password, leave the input field empty and press Enter.
- 5 Enter your password again in [Confirm New Password] and press Enter.**
- 6 In [Setup Notice], press Enter.**
- 7 Press F10, and then select [Yes] and press Enter.**

### CAUTION

- Do not forget your password. If you forget your Supervisor Password, you will not be able to use your computer. Contact Panasonic Technical Support.
- When running the Setup Utility, do not leave and go away from your computer even for a short time, since other people may set or change the password.

### NOTE

- The password will not be displayed on the screen.
- You can use up to 32 alphanumeric characters (including spaces).
  - The case (upper/lower) is ignored.
  - Use only the upper horizontal row of numeric keys to input your password.
  - You cannot use **Shift** and **Ctrl** to input a password.
- Disabling the Supervisor Password also disables the User Password.



## Preventing Your Computer from Unauthorized Use

You can set a start-up password to protect your computer from unauthorized use.

- 1 **Set the password (→ page 8), and select [Enable] in [Password on boot] in the [Security] menu of the Setup Utility (→ page 67).**

### NOTE

- If the Supervisor Password or User Password has been set, the password input screen will be displayed on starting-up of the Setup Utility even though [Password on boot] is set to [Disable].

## Preventing Your Hard Disk Data from Being Read or Written

The hard disk lock function protects the hard disk data from being read or written when the hard disk is attached to another computer. The data can be read/written when the hard disk is returned to the original computer.

- 1 **Select [Enable] in [Hard Disk Lock] in the [Security] menu of the Setup Utility (→ page 67).**

### CAUTION

- For the data being read/written on the original computer, the Setup Utility settings must be the same as when the hard disk was removed.
- You cannot use the hard disk lock function without setting the Supervisor Password. Set the Supervisor Password beforehand (→ page 8).
- When you have your hard disk drive repaired
  - Contact Panasonic Technical Support.
  - Before sending back the hard disk drive, be sure to set the [Hard Disk Lock] to [Disable].

### NOTE

- The hard disk lock function works with the built-in hard disk. It does not work with the external hard disk.
- We recommend you to set [Password on boot] to [Enable] to ensure security though it is not required to enable the hard disk lock. (Note that the hard disk lock does not guarantee complete protection of the data.)

## Disabling CD/DVD Drive

Disable CD/DVD drive operation to prevent the drive(s) from being read/written and from being used to start the computer. You can protect your data from unauthorized access or accidental overwriting.

- 1** Select **[Disable]** in **[DVD Operation]** in the **[Security]** menu of the Setup Utility (→ [page 67](#)).

### NOTE

- This does not work for USB CD/DVD drive.

## Battery Indicator

Battery indicator	Battery status
Not lit	The battery pack is not inserted or not being charged.
Orange	Charging is in progress.
Green	The battery is fully-charged.
Blinking green	In high temperature mode, the battery pack is discharging the power to 80% <sup>*1</sup> of normal temperature mode (→ <a href="#">page 13</a> ). Do not remove the battery pack in this status.
Red	The remaining battery is approximately 9% or less.
Blinking red	The battery pack or the charging circuit is not operating properly.
Blinking orange	The battery cannot be charged temporarily due to the following reasons: <ul style="list-style-type: none"><li>• Its internal temperature is out of the acceptable range.</li><li>• The power supply is not enough because software applications or peripheral devices are consuming a large amount of power.</li></ul>

<sup>\*1</sup> In high temperature mode, the 100% battery level is equivalent to 80% level of the normal temperature mode.

### NOTE

- Once the battery is fully charged, the computer performs recharging only when the battery level becomes less than approximately 95%, so overcharging is avoided.

## Checking the Remaining Battery Charge

You can check the remaining battery charge on the screen.

(After logging on to Windows)

### 1 Press **Fn+F9**.

- When the battery pack is inserted (example)



: Normal temperature mode (→ [page 13](#))



: High temperature mode (→ [page 13](#))

- When the battery pack is not inserted



### NOTE

- The battery display may not correspond to the actual remaining battery charge in the cases as below. To correct the display, perform the Battery Recalibration (→ [page 15](#)).
  - The battery indicator remains red.
  - The indicator lights orange and the display shows 99% for a long time.
  - Low battery warning appears soon after a short time of use.This can occur when the computer is in standby mode for a long time without power supply from the AC adaptor.
- The battery display may not be the same as that of notification area or of [Power Meter] in [Power Options Properties]. This is not a malfunction.

## High temperature mode

---

The high temperature mode can prevent the battery from deteriorating when the computer is used in high-temperature environment or used for a long time with its battery fully charged.

Select [Auto] (default) or [High Temperature] in [Environment] of the [Main] menu of the Setup Utility (→ [page 65](#)).

### NOTE

- Note that a level corresponding to a 100% charge for high temperature mode is approximately equivalent to an 80% charge level for normal temperature mode.
  - After switching from [Normal Temperature] to [High Temperature] or vice versa, the remaining battery capacity will not be displayed correctly until the battery pack is completely discharged or fully charged.
  - In the [Auto] mode:  
Once the computer has automatically switched from the normal temperature mode to the high temperature mode, the computer will not switch back to the normal temperature mode until the battery has been used and recharged to a total charge level of about five times as much as that of the fully-charged state. This is to avoid battery deterioration.
-

## Computer behavior with low battery

The default settings are as follows.

When the battery level becomes 10% [Low battery alarm]	When the battery level becomes 5% [Critical battery alarm]
<ul style="list-style-type: none"><li>● Displays a message that the battery level is low.</li></ul> <p style="text-align: center;">↓</p>	<ul style="list-style-type: none"><li>● Displays a message that the battery level is low, and then the computer enters hibernation.</li></ul> <p style="text-align: center;">↓</p>
<p>Charge the battery.</p>	<p>Connect the AC adaptor or replace the battery to start up the computer.</p>
<ul style="list-style-type: none"><li>● Connect the AC adaptor immediately. If you do not have the AC adaptor, exit the running programs and Windows, then confirm that the power indicator is off.</li><li>● If you have a fully charged spare battery, turn off the computer, replace the battery and turn the computer on again.</li></ul>	<ul style="list-style-type: none"><li>● Connect the AC adaptor and charge the battery.</li><li>● If you have a fully charged spare battery, replace the battery and turn the computer on again.</li></ul> <p>When the computer enters hibernation with the battery down and you resume the operation without charging the battery, Windows may not start up normally or the alarm function may not operate normally from then on.</p>
<p>Do not replace the battery pack when the computer is in standby mode.</p>	

## Correcting the Battery Display (Battery Recalibration)

The “Battery Recalibration” function measures and memorizes the battery capacity. To correct the battery display, use this function to fill the battery and then discharge it completely. Perform the procedure at least once immediately after purchasing the computer. Normally the interval of battery recalibration is three months. The battery display may not be correct when the battery pack deteriorates after a long time use. In this case, perform the procedure again.

### 1 Connect the AC adaptor.

### 2 Close all the applications.

### 3 Perform “Battery Recalibration”.

① Click [start] - [All Programs] - [Panasonic] - [Battery Recalibration].

② When the confirmation message appears, click [Start].

- Frequent recalibration of the battery can degrade the battery. A caution message appears when the battery recalibration is performed at the shorter interval than approximately a month. In this case, cancel the battery recalibration.

③ When the message requests shut down of Windows, click [Yes].

The battery recalibration starts.

After the battery pack is fully charged, discharging starts. When the discharging is completed, the power goes off automatically.

After the battery recalibration is finished, normal charging starts.

#### NOTE

- The temperature range should be 10°C to 30°C {50°F to 86°F}.
- The battery recalibration may take a long time due to the large battery capacity. This is not a malfunction.
  - Full charge: Approximately 4 hours
  - Complete discharge: Approximately <CF-52A/B series> 3.5 hours, <CF-52C/D series> 4.5 hours
- If the computer is turned off during the battery recalibration (e.g., due to power failure, or accidental removal of the AC adaptor and battery pack), the battery recalibration will not be completed.
- You can also perform the battery recalibration with the following procedure.
  - ① Restart the computer.
  - ② Press **F9** while the [Panasonic] boot screen is displayed just after the computer starts the startup procedure.
  - ③ When the remaining battery capacity is displayed, press **Enter**.
  - ④ Follow the on-screen instructions.

## Replacing the Battery Pack

The battery pack (CF-VZSU29AU) is a consumable item so the replacement will be necessary. If the battery operation time becomes noticeably short and not recovered even after recalibrating the battery, replace with a new battery.

### CAUTION

- The battery pack is not charged when you first purchase it. Be sure to charge it before using for the first time. Charging starts automatically when the AC adaptor is connected to the computer.
- Use only the specified battery pack with your computer.
- In the standby mode, do not remove/replace the battery pack. Otherwise your data will be lost and the computer may be damaged.

### 1 Turn off the computer.

- Do not use the standby function.

### 2 Reverse the computer and remove the cover.

- ① Press and hold the **PUSH** mark part (A).
- ② Slide and remove the cover.

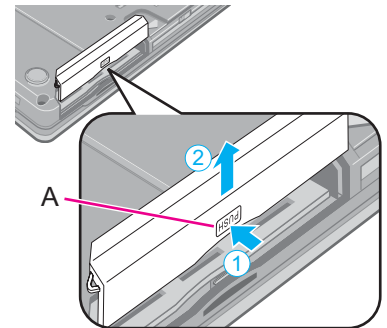

### 3 Remove/Insert the battery pack.

- To remove  
Slide and hold the latch (B), and pull the tab (C) of the battery pack.

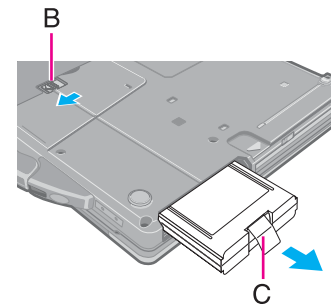



- To insert  
Insert the battery pack until it securely fits the connector.

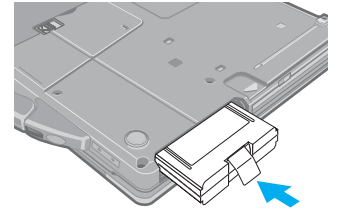

## 4 Slide the cover back.

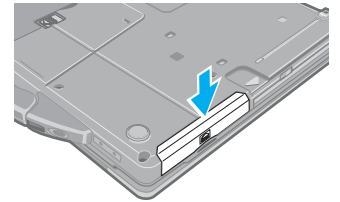



### CAUTION

- Make sure the latch is securely locked, otherwise the battery pack may fall when you carry the computer.
- Do not remove the battery pack forcibly when the latch is locked. Doing so may damage the battery pack.

You can attach the following device. (refer to recent catalogs and other sources for information about the products available)

- DVD MULTI drive

## CAUTION





- Do not insert/remove the multimedia pocket device in standby or hibernation, or when the multimedia pocket device indicator  or the hard disk drive indicator  is on.
- Do not leave a disc formatted with B's CLiP in the multimedia pocket device because the computer cannot enter standby/hibernation even if you selected [Stand by] or [Hibernate] in [When I close the lid of my portable computer:] (→ [page 5](#) "Setting Standby or Hibernation").

## NOTE

- Refer to the catalogs etc. for the latest information about optional devices.
- Read the instruction manuals of the devices carefully.

## Replacing the Multimedia Pocket Device

### 1 Disable the multimedia pocket device function.

- ① Double-click  on the notification area.
  - ② Select the multimedia pocket device and then click [Stop].
  - ③ Follow the on-screen instructions.
  - ④ Confirm that the multimedia pocket device indicator  and the hard disk drive indicator  indicators are not lit.
- This step is not necessary when;
    - Removing the device after turning off the computer.
    -  is not displayed.
    - The device does not appear in the list in step ②.

### 2 Press and hold the release button (A), and slide the device out of the multimedia pocket.

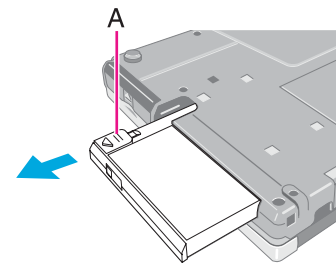

### 3 Carefully insert the device into the multimedia pocket by pushing both corners until it surely fits in the slot.

- The computer must be on when inserting the device.
- Insert the device with the label side up.

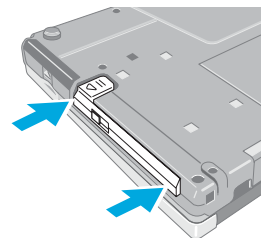

#### CAUTION

- Hold the device on its both sides. Otherwise the device may be damaged.
- Do not apply excessive force when raising the slot side upward and inserting the device.
- When you carry the computer, confirm that the release button is surely locked so that the device does not fall.
- Be sure to insert the device into the multimedia pocket for use.

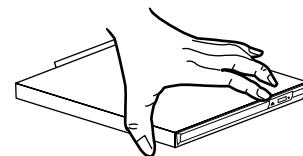

#### NOTE

- The procedure to disable the multimedia pocket device is not necessary when you remove the device after turning off the computer.
- You can see that the device is recognized or not by double-clicking  on the notification area, or checking the [Information] menu in the Setup Utility (→ [page 64](#)). If the device is not recognized (or if the media cannot be accessed), turn off the computer and reinsert the device.



## Handling Precautions

### CD/DVD drive handling care

---

- Do not expose the CD/DVD drive to excessive smoke that may leave a residue, e.g., oil smoke, or tobacco smoke. Doing so can shorten the life of the drive lens.
- We recommend cleaning the drive lens with an air puffer used for camera lenses.  
(Do not use any spray-type of lens cleaning products.)

#### When opening/closing the tray

- When the computer is on, use the eject button (→ [page 25](#)) or eject through Windows.
- When  is displayed on the notification area, right-click  and click [Eject] to eject a disc.  
Eject discs only as described above.
- When inserting or removing a disc, be careful not to touch the lens of the drive.
- Do not leave the tray open and do not touch the lens.  
The lens and disc can become dusty in some conditions. It may cause malfunction in reading or writing.
- Do not apply excessive force to the tray in the open position.
- Never insert a foreign object such as a paper clip into the CD/DVD drive.  
Doing so may cause malfunction.
- Do not place items other than discs on the tray.
- Do not access the drive until after the tray is closed and the multimedia pocket device indicator  is off.

#### While the CD/DVD drive is being accessed

- Do not open the CD/DVD drive or move the computer while the CD/DVD drive is being accessed.  
Doing so could cause the disc to shift position and this may damage the disc, or cause the CD/DVD drive to malfunction.  
In addition, after running an application involving access to a disc, close the application before opening the CD/DVD drive.

## Disc handling care

- Do not use deformed, warped, or irregularly shaped discs.  
Reading of disc may not be possible depending on the disc conditions (cracks, dirt, modification, data recording quality, copy protection, recording equipment/software that was used to create the disc, etc.)
- Before using a disc, carefully read the operating/handling instructions and package of the disc.
- If the discs are not handled appropriately, they may become dirty or scratched. Furthermore the writing speed may get slower and the data may not be correctly written on or read from the disc. Other damage may cause a drive failure.
- Note the following precautions.
  - Do not touch the disc surface (the side with no printing).
  - Keep the disc surface clean and free from dirt, dust, fingerprints and scratches.
  - Do not write on the surface of the disc with a ballpoint pen or other writing instrument.
  - Do not attach stickers to discs.
  - Do not drop, bend, or place heavy objects on top of discs.
  - Do not place or store discs in locations exposed to heat, direct sunlight, humidity or dust.
  - If a disc is brought from a cold to a warm location, condensation may form on the disc. For read-only discs, wipe off the condensation using a soft, dry, lint-free cloth before using the disc. For recordable/rewritable discs, wait until the condensation dries.
  - When not using discs, keep them in their protective cases or cartridges.

### To clean discs

<For read-only discs>

Wipe discs with a dry, soft cloth from the center toward the edge.

If discs get very dirty, wipe with a moist, soft cloth from the center toward the edge, then wipe again with a dry cloth to take up remaining moisture.

<For recordable/rewritable discs>

Use the Panasonic disc cleaner to clean these discs.

Do not use a cloth, CD cleaners or any other such cleaners under any circumstances.





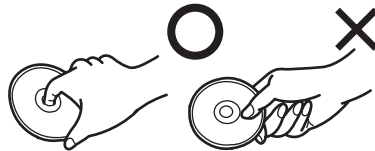

### How to hold a disc









## Disc Information







- You can read from/write to the following discs.

CD-R	CD-RW		
			

- You can read from the following discs.

CD-ROM	CD DIGITAL AUDIO	CD TEXT	CD-EXTRA	Video CD	Photo CD
					

- You can write to the following discs.

DVD-RAM*1	DVD-R	DVD-R DL	DVD-RW*2	DVD-ROM	DVD-Video
					

+R	+R DL	+RW	
			

\*1 DVD-RAM: Only non-cartridge type or removable cartridge type can be used.

\*2 Does not support DVD-RW Ver.1.0.

## ■ Recommended discs for writing

- CD-R
  - HITACHI MAXELL, Ltd.
  - mitsubishi kagaku media co., Ltd.
  - TAIYO YUDEN Co., Ltd.
- CD-RW/High-Speed CD-RW
  - mitsubishi kagaku media co., Ltd.
  - RICOH Co., Ltd.
- Ultra-Speed CD-RW
  - mitsubishi kagaku media co., Ltd.
- DVD-R
  - Matsushita Electric Industrial Co., Ltd.
  - mitsubishi kagaku media co., Ltd.
  - TAIYO YUDEN Co., Ltd.
- DVD-R DL
  - mitsubishi kagaku media co., Ltd.
- DVD-RW
  - mitsubishi kagaku media co., Ltd.
  - Victor Company of Japan, Limited
- DVD-RAM
  - Matsushita Electric Industrial Co., Ltd.
  - HITACHI MAXELL, Ltd.
- +R / +RW
  - mitsubishi kagaku media co., Ltd.
  - RICOH Co., Ltd.
- High-Speed +RW
  - RICOH Co., Ltd.
- +R DL
  - mitsubishi kagaku media co., Ltd.

## ■ DVD discs you can use for writing

- DVD-R for General
  - 1X-SPEED (4.7 GB)
  - 1–2X-SPEED (4.7 GB)
  - 1–4X-SPEED (4.7 GB)
  - 1–8X-SPEED (4.7 GB)
  - 1–16X-SPEED (4.7 GB)
- DVD-R DL
  - 2–4X-SPEED (8.5 GB)
  - 2–8X-SPEED (8.5 GB)
- DVD-RW
  - 1X-SPEED (4.7 GB/9.4 GB)
  - 1–2X-SPEED (4.7 GB/9.4 GB)
  - 2–4X-SPEED (4.7 GB/9.4 GB)
  - 2–6X-SPEED (4.7 GB/9.4 GB)
- DVD-RAM
  - 2X-SPEED (4.7 GB/9.4 GB)
  - 2–3X-SPEED (4.7 GB/9.4 GB)
  - 2–5X-SPEED (4.7 GB/9.4 GB)
- +R
  - 1–2.4X-SPEED (4.7 GB)
  - 1–4X-SPEED (4.7 GB)
  - 1–8X-SPEED (4.7 GB)
  - 1–16X-SPEED (4.7 GB)
- +R DL
  - 2.4X-SPEED (8.5 GB)
  - 2.4–8X-SPEED (8.5 GB)
- +RW
  - 1–2.4X-SPEED (4.7 GB)
  - 1–4X-SPEED (4.7 GB)
- High-Speed +RW
  - 3.3–8X-SPEED (4.7 GB)

## Using DVD Media

---

To play DVD-Video or MPEG2 files, you need to use DVD playback software such as WinDVD (→ [page 27](#)).

### ■ Region code setting

DVD-Video are allocated to region codes according to where they are sold. To play a DVD-Video, the player's software and the drive must have the corresponding region code.

e.g.,

For U.S.A. and Canada: "1"

For Europe: "2"

- The region code of the drive is not set at purchase. The operation depends on the DVD-Video that is first played.
  - **DVD-Video with a specific region code:**  
The drive will automatically be set at the same region code as the DVD-Video.
  - **DVD-Video with multiple region codes:**  
[Confirm Region] appears. Select the region code and click [OK]. Play now begins.

### CAUTION

---

- You can change the region code setting up to five times including the initial setting. Be extremely careful because you cannot change the region code anymore after the fifth change, even if you reinstalled the operating system.
  - Any problem resulting from illegal changing or altering of the region code is the user's responsibility.
- 

### NOTE

---

- [Confirm Region] appears when the DVD-Video has only one region code and the drive is set for another region code. ([Confirm Region] may not appear with some DVD-Video discs. To check the current region code and the number of remaining times of changing the code, right-click on the WinDVD screen and click [Setup] - [Region].)
-



## Setting a Disc

- 1 Turn on the computer.**
- 2 Press the eject button (A) and slowly pull out the tray.**
- 3 Insert/Remove the disc.**
  - To insert  
Set the disc with the label side up and press the center of the disc until it clicks in place.
  - To remove  
Press on the center spindle (B) and carefully lift up the edge of the disc.
- 4 Close the tray.**

Do not press the eject button.

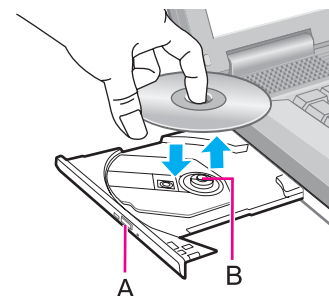

### NOTE

- To remove a disc when the computer is powered off, insert a pointed object (e.g., the bent-out tip of a paper clip, or the tip of a pencil or ballpoint pen) into the emergency hole (C). Pushing it to the end allows the tray to come out. (The position of the emergency hole depends on the drive.)
- If the vibration of the CD/DVD drive is excessive, check the disc. If the disc is normal and is inserted correctly, set [DVD Drive Speed] to [Low] in the [Main] menu of the Setup Utility (→ [page 65](#)).  
When using B's Recorder, select writing speed [8x] or less to minimize vibration.
- For AutoPlay CD:
  - If an AutoPlay CD does not start after the computer resumes from standby or hibernation, remove the disc from the drive and then reinsert it after waiting 15 seconds.
  - An AutoPlay CD may start during file access depending on the status of the disc.
- When playing back video from a disc, playback may not be smooth in some conditions.

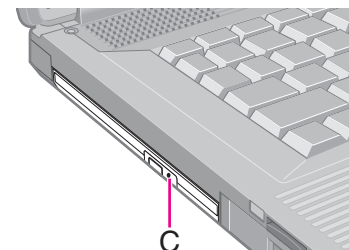

## Power-saving mode

If the CD/DVD drive is not accessed for 30 seconds, the drive motor will automatically be shut down to reduce the power consumption. When the CD/DVD drive is accessed again, the drive motor is turned on. In this case, reading of the disc data will take approximately 30 seconds.

### DVD MULTI Drive

- If a DVD MULTI drive has already been set at the time of initial startup of the computer, you do not need to install the DVD-RAM Driver. You can write to a DVD-RAM disc without installation. If you purchase a DVD MULTI drive after the initial startup of the computer, install the DVD-RAM Driver according to the operating instructions supplied with the drive.

WinDVD is a software application for DVD playback. For further information, refer to the software's online manual.

- DVD-Audio cannot be played back using WinDVD.

## Running WinDVD

### 1 Double-click on the desktop.

- Alternatively click [start] - [All Programs] - [InterVideo WinDVD] - [InterVideo WinDVD].

### ■ To access the online manual

After starting WinDVD, perform either of the following procedures.

- Click “?” on the WinDVD control panel.
- Right-click on the WinDVD screen and click [Help].

#### SUPPORT INFORMATION

If WinDVD does not operate properly, we recommend carefully reading the online help file first for problems with the operating environment or operations.

If you still cannot troubleshoot the problem, enter the required information in the inquiry form on the InterVideo, Inc. homepage (<http://www.intervideo.com/>), and submit the form.

#### CAUTION

- Do not start WinDVD while the hard disk drive indicator  is blinking immediately after the computer is turned on.
- While WinDVD is running, do not:
  - Enter standby or hibernation.
  - Switch the display by pressing **Fn** + **F3**.
- During video playback, do not:
  - Eject the disc.
  - Use other applications or the Command Prompt.
  - Change the settings of the screen properties.
- Do not install another player software together with WinDVD.  
Doing so may interfere with smooth playback. Some DVD-Video discs contain the player software and start installing. In this case, cancel the installation as soon as possible. If you accidentally installed another player software and find a problem in playback, try either of the following procedures.
  - Uninstall the player software by clicking [start] - [Control Panel] - [Add or Remove Programs].  
(Refer to the instruction manual for the name of player software.)
  - Set WinDVD as the playback software if you can select the option in the player software settings.

## DVD Discs Created Using a DVD Recorder

- Playback may not be possible depending on the DVD recorder or the discs.
- You must finalize<sup>\*1</sup> DVD-R, DVD-R DL, DVD-RW, +R, +R DL, and +RW before playback. For further information, refer to the instruction manual of the DVD recorder.
- You cannot play discs protected with copyright management technologies such as CPPM (Content Protection for Pre-recorded Media) and CPRM (Content Protection for Recordable Media).

<sup>\*1</sup> A process that enables the playback of the discs on other DVD players, etc.

“B's Recorder” and “B's CLiP” are CD/DVD recording software applications developed by B.H.A Corporation.

- B's Recorder:  
Enables you to create data/music/video CDs and to copy CDs.
- B's CLiP:  
Enables you to copy or erase files and folders.

For further information, refer to the software's online manual (→ [page 31](#)).

## ■ Applicable Media

- CD-R\*<sup>1</sup>
- CD-RW
- DVD-RAM\*<sup>1</sup> \*<sup>2</sup>
- DVD-R\*<sup>1</sup>
- DVD-R DL
- DVD-RW \*<sup>3</sup>
- +R\*<sup>1</sup>
- +R DL\*<sup>1</sup>
- +RW

\*<sup>1</sup> You can use on B's Recorder only, and cannot read from or write to the disc using B's CLiP.

\*<sup>2</sup> If you write to DVD-RAM using B's Recorder, the DVD-RAM will become “read only” disc.  
To write to such a DVD-RAM disc using an application other than B's Recorder, physical formatting is required.

\*<sup>3</sup> You cannot read from or write to DVD-RW created using DVD recorders.

### **About Copies**

When you write to discs or back up software, ensure that you do not infringe upon any copyrights.  
It is illegal to copy audio CDs for non-personal use.

## Running B's Recorder/B's CLiP

### ■ B's Recorder

1 Double-click  (B's Recorder main window) /  (launcher window) on the desktop.

- Alternatively you can click [start] - [All Programs] - [B.H.A] - [B's Recorder GOLD8 BASIC] - [B's Recorder GOLD8] (B's Recorder main window) / [TaskGate] (launcher window).

### ■ B's CLiP

You can use B's CLiP when  or  is displayed on the notification area.

 : No disc is inserted or the inserted disc is not formatted using B's CLiP.

 : The inserted disc has been formatted using B's CLiP.







 : The drive is not connected.

#### CAUTION

#### B's Recorder

- Be sure to shut down B's Recorder before you log off Windows. Otherwise B's Recorder may not start normally when you log on to Windows next time. In this case, restart the computer.

#### B's CLiP

- B's CLiP is not compatible with fast user switching (the  and  icons disappear from the notification area). If you want to continue using B's CLiP after switching users, log off all users, and then relog on to Windows.
- Do not remove the media immediately after reading or writing, or just after the Windows reading/writing message disappears.
- When  is displayed on the notification area, the computer will not enter standby automatically.
- Do not add the check mark for [Enable CD recording on this drive] in [Properties] - [Recording] of the CD/DVD drive, otherwise you cannot write to the disc using B's CLiP.
- You can format DVD-RW discs in UDF1.5/UDF2.0/UDF2.01 format on this computer. However, you cannot use the discs on DVD recorders.
- Formatting +RW discs on B's CLiP may seem to finish in a very short time. However the "background formatting" is performed to format the non-formatted segments. Therefore, the multimedia pocket device indicator  is on. Note the following during background formatting.
  - You can read from or write to a disc.
  - You can remove the disc even while the multimedia pocket device status indicator  is on. Right-click  on the notification area and click [Eject] to remove the disc.

- If the disc is removed before completely formatted, the background formatting will restart when the disc is returned to the drive. Background formatting will continue until the formatting is complete.
  - To carry the computer, right-click  on the notification area and click [Eject] to remove the disc.
- 

## ■ To access the online manual

### B's Recorder

- ① Click [start] - [All Programs] - [B.H.A] - [B's Recorder GOLD8 BASIC] - [DOC] - [User Manual] (user's manual) / [TaskGate] (TaskGate manual).

### B's CLiP

- ① Click [start] - [All Programs] - [B.H.A] - [B's CLiP] - [User's Manual].

You can insert the following cards.

- ExpressCard/34 or ExpressCard/54 to the ExpressCard slot (A)  
(Only for model with ExpressCard slot)
- PC Card Type I (3.3 mm) or II (5.0 mm) to the PC Card slot (B)



## NOTE

- The following types of card are not supported:  
PC Card Type III (10.5 mm), ZV card, SRAM card, FLASH ROM card (excluding ATA interface type), and other cards that require 12 V of operating voltage.

## Inserting/Removing the Card

### Preparation

- Before connecting a card, first determine the media that contains the card driver (e.g., CD-ROM), then attach the device for that media to the multimedia pocket. Once the installation screen for the card's driver appears, equipment you then connect to the multimedia pocket will not be recognized.
- If the dummy card is inserted, remove it.

### ■ To insert the card

- 1 **Open the cover (C), and insert the ExpressCard (D) or the PC Card (E) with the label side up until it securely fits in to the slot.**
  - For further information, refer to the instruction manual of the card.

### ■ To remove the card

- 1 **Disable the card function.**
  - ① Double-click  on the notification area and select the card, then click [Stop].
  - ② Follow the on-screen instructions.
    - This step is not necessary when removing the card after turning off the computer.

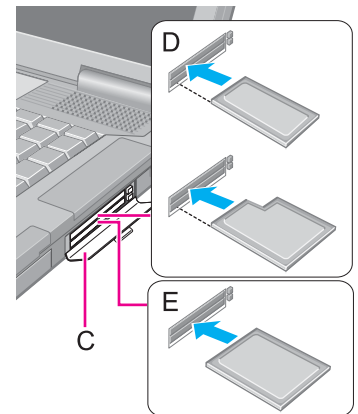



## 2 Open the cover and remove the card.

- ① Press the eject button (F). The eject button pops out.
- ② Press the eject button (F) again so the card comes out of the slot.
- ③ Draw the card straight out.

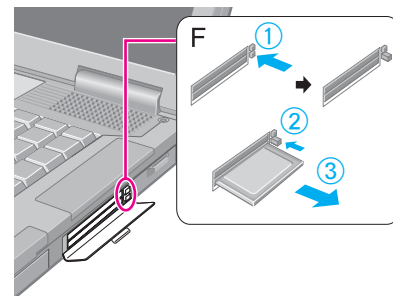

### NOTE

- Check the card's specification to prevent the total operating current from exceeding the allowable limit. Otherwise malfunction may occur.  
Allowable Current: 3.3 V: 400 mA, 5 V: 400 mA
- Some types of cards cannot be used simultaneously.
- After repeating insertion and removal, some types of card will not be recognized. In this case, restart the computer.
- If the computer freezes after resuming from standby or hibernation, remove and reinsert the card. If the problem persists, restart the computer.
- When a card is inserted, power consumption increases. Remove the card when it is not in use, especially when operating by battery power.
- To connect peripheral devices (SCSI, IEEE1394, etc.) using PC Card or an ExpressCard, follow the steps below (one example).
  - ① Connect the peripheral device to the card.
  - ② Turn on the power of device.
  - ③ Insert the card until it surely fits in the slot.

## SD Memory Card Information

The SD Memory Card slot on this computer only accepts SD Memory Cards.

- This computer does not support SDHC Memory Card (SD Memory Card with the capacity of 4 GB or more).
- When you use a miniSD Card or a microSD Card, set the card to a miniSD Card adaptor or a microSD Card adaptor, and insert/remove the card with the adaptor. Be sure not to leave the adaptor in the card slot.
- The SD Memory Card has a copyright protection function which is compatible with content on-demand services on the Internet, etc.
- To format the SD Memory Card on this computer, do not use [Format] of Windows, but use the SD Memory Card format software.

You can download the software from the web site below.

[http://panasonic.jp/support/global/cs/sd/download/sd\\_formatter.html](http://panasonic.jp/support/global/cs/sd/download/sd_formatter.html)

- To use the SD Memory Card on other devices, format the card on the devices. For further information, refer to the instruction manual of the devices.

### Handling and storage cautions

- Store the SD Memory Card in the case after removing it from the computer.
- Do not:
  - Disassemble or modify the card.
  - Hit, bend, or drop the card.
  - Touch the terminals with fingers or metal object.
  - Remove the labels of the card / Attach other labels or stickers to the card.
- Do not place the card in the following locations.
  - In direct sunlight or in very hot location such as inside of a car.
  - In very dusty or humid location.
  - In location subject to corrosive gas, etc.

### Data handling cautions

- Set the write-protect switch (A) to the LOCK position. Unlock the switch when recording (checkout), saving, or editing data.
- We recommend you to back up the important data to another storage medium.
- When disposing the card, we recommend you to physically destroy the card (using a hammer, etc.) to prevent personal or confidential data leakage.

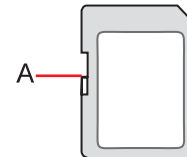

## Inserting/Removing the SD Memory Card

### CAUTION

- Do not remove or insert the SD Memory Card until Windows has completed loading.
- Do not remove the card or turn off the computer in the following cases, otherwise the data may be corrupted.
  - While the computer is in standby or hibernation.
  - While the SD Memory Card indicator  is on.
  - While data is being read from or written to the card.
  - Immediately after the writing operation. The computer may still continue the access to the card just after writing operation. If you remove the card before the operation is completed, the data may be damaged or the card access may no longer be performed normally.
- Note that Panasonic assumes absolutely no liability for any loss of data recorded by the user, or any other damages, direct or indirect.
- Do not forcibly draw out the card or the dummy card, otherwise the slot may be damaged.
- Insert the card in the correct direction, otherwise the card and the slot may be damaged.
- After resuming from standby or hibernation, do not access the SD Memory Card for approximately 30 seconds.

### ■ To insert the card

- 1 **Insert the SD Memory Card with the label side facing up and with the cut corner in front.**

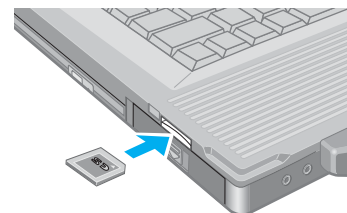

### ■ To remove the card

#### Preparation

- Save the data and close all applications.
- Confirm the SD Memory Card indicator  (B) is off.

- 1 **Disable the card function.**

- ① Double-click  on the notification area and click [Secure Digital Storage Device], then click [Stop].
- ② Follow the on-screen instructions.
  - This step is not necessary when removing the card after turning off the computer.

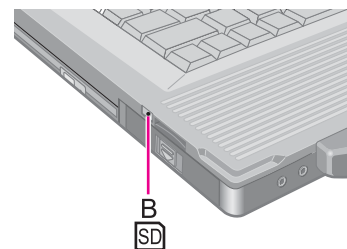

## 2 Remove the card.

- ① Press the card so it comes out of the slot.
- ② Draw it straight out.

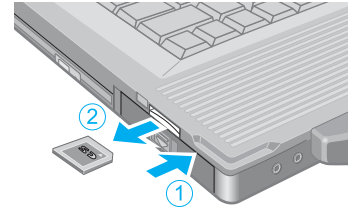

Inserting a specific SD Memory Card can work as an alternative to entering password in the cases below. Format the card and make the necessary settings.

- Starting up the computer
- Resuming the computer from standby, hibernation or screensaver
- Logging on to Windows

## NOTE

- You can start up the computer by entering the Supervisor Password or User Password when you do not use the SD Memory Card.
- Use the formatted SD Memory Card (→ [page 34](#)).
- This function works only with the SD Memory Card slot. It does not work with other devices such as an SD card reader/writer connected through USB port.
- You cannot use this function together with the fingerprint security (optional).
- You can use the setup SD Memory Card as an ordinary card on the computer and other devices.
- You can use a single setup SD Memory Card for multiple computers. However, when using the card to log on to Windows, you need to use the same logon user name and the same password on all of the computers.

## SD Card Setup

### Preparation

- To start up the computer  
Set the Supervisor Password in the Setup Utility (→ [page 8](#)). (You can also set it during the configuration procedure.)
- To use the card to log on to Windows or to resume from standby, hibernation or screensaver  
Set the Windows logon user account and the password in [Control Panel] in advance. For further information, refer to the Windows Help.

- 1 Log on to Windows as an administrator.**
- 2 Insert the SD Memory Card in the SD Memory Card slot.**  
If [Secure Digital storage device] appears, click [Take no action], then click [OK].
- 3 Start the SD Card Setup program.**  
Click [start] - [All Programs] - [Panasonic] - [SD Card Setup].
- 4 Click [Next] in the Welcome screen.**

## 5 Select the trigger operation (A).

### [Leave set]

Insert and leave the card in the slot.  
(You can remove the card afterward.)

### [Set and eject]

Insert the card and eject it.

When logging on to Windows or resuming from standby, hibernation or screen-saver, eject the card after the beep sounds to indicate card recognition. If the speakers are muted, beeps do not sound.

- Make the setting on each computer. You cannot use different settings on the same computer even with the different SD Memory Cards.
- To select different settings for starting the computer and logging on to Windows:  
In this screen, set the trigger operation to log on to Windows. After completing the SD Card Setup, start the Setup Utility and select the setting to start up the computer in [SD Setting Method] of the [Security] menu (→ page 67).

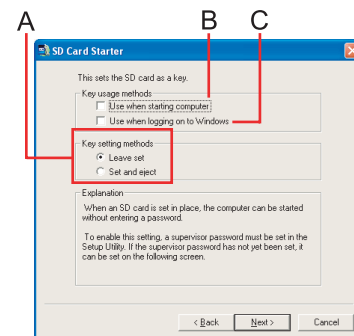

## 6 Make the necessary settings.

### To start up the computer

The SD Memory Cards will be registered to the computer.

- You can register up to two cards (To set up the second SD Memory Card: → page 39).
- ① Add the check mark for [Use when starting computer] (B) and click [Next].
- ② Click [Restart the computer after entering settings] and click [Finish].
- ③ Enter the Supervisor Password and click [OK].
- If the Supervisor Password is not set, follow the on-screen instructions to set the Supervisor Password.
- You can use up to 32 alphanumeric characters (including spaces).
  - The case (upper/lower) is ignored.
  - To input numbers for the password, use the numbered keys on the keyboard.
  - You cannot use **Shift** and **Ctrl** to input a password.

### To use the card to log on to Windows

The Windows logon user name and the password set in [Control Panel] are registered in the SD Memory Card.

- ① Add the check mark for [Use when logging on to Windows] (C) and click [Next].
- ② Click [Restart the computer after entering settings] and click [Finish].
- ③ Enter the Windows logon user name and the password.

- After making this setting, the following functions will be disabled.
  - Displaying the Welcome screen
  - The Fast User Switching function
  - Remote desktop connection
- When you add the check mark for [Do not check the user name], you can register a user name that is different from the Windows user name. Click [Yes] at the confirmation message. When restarting the computer and logging on to Windows, you will need to enter the Windows user name and the password without using the SD Memory Card.
- A [PRIVATE] folder will be created in the SD Memory Card, and the encrypted Windows logon user name and the password will be registered.  
Do not delete [PRIVATE] folder. Doing so will cancel [Use when logging on to Windows].

### To use both when starting the computer and when logging on to Windows

Add the check mark to both [Use when starting computer] and [Use when logging on to Windows], and follow the above steps.

#### CAUTION

- Do not lose the setup card.
- Do not leave the setup card in the slot when you go away from the computer.

## ■ To change the settings / To set up the second SD Memory Card

- ① Start the SD Card Setup program (→ page 37 Step 1-3).  
The screen is different from the initial setup screen.
- ② Change the settings.  
**[Setting for this computer]**  
You can change the settings registered in this computer.  
**[Setting for this SD card]**  
You can change the settings of the inserted SD Memory Card.
- ③ Click [OK].
- ④ Make the necessary settings.
  - Refer to the initial setup procedure above.
  - You may need to enter the password to proceed the steps.
- ⑤ Restart the computer.

## ■ To disable the setup card

If you have lost the setup card, disable the card to avoid unauthorized startup or logon.

### When using the card to start up the computer

- ① Start the SD Card Setup program. (→ [page 37](#) Step**1-3**)  
The current settings will be displayed.
- ② Remove the check mark from [Use the SD card when starting the computer].
- ③ Click [OK], and then follow the on-screen instructions.  
All SD Memory Cards currently registered on this computer will no longer be usable to start up the computer.
  - Even if you add the check mark again for [Use the SD card when starting the computer], the card will not be usable to start up.

### When using the card to log on to Windows

- ① Change the Windows logon password.  
The card will no longer be usable to log on to Windows.



<Only for model with Smart Card slot>

You need software to use a Smart Card.

## CAUTION

- Do not:
  - Hit, bend, or drop the card.
  - Touch the contact part with fingers or metal object.
  - Place the card in very hot location for a long time.
  - Remove the card immediately after inserting it.

## Inserting/Removing the Smart Card

### ■ To insert the card

**1** Insert the Smart Card with the contact part (A) in front.

- Insert the card until it surely fits in the slot.

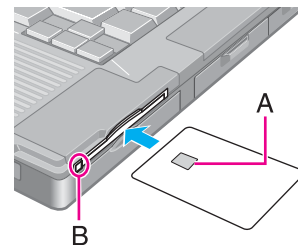

### ■ To remove the card

**1** Press the eject button (B).

The Smart Card pops out.

## CAUTION

- Use the eject button to remove the card, otherwise the reading contact may be damaged.

Use RAM modules that comply with the specifications below. Using any other module may cause malfunction or result in computer failure.

RAM module specifications:

200 pins, SO-DIMM, 1.8 V, DDR2 SDRAM, PC2-5300

(For information of RAM module compatibility, contact Panasonic Technical Support.)

## CAUTION

- RAM modules are extremely sensitive to static electricity and can be affected even by static electricity from the human body. When inserting and removing RAM modules, do not touch the terminals or internal components, and do not allow foreign particles to enter the slots. Doing so may cause damage, fire, or electric shock.

## Inserting/Removing the RAM Module

This computer has two RAM module slots.

- When using a RAM module, insert it in SLOT: 1. (At purchase, the RAM module is in SLOT: 1.)
- When using an extra RAM module, insert it in SLOT: 2.

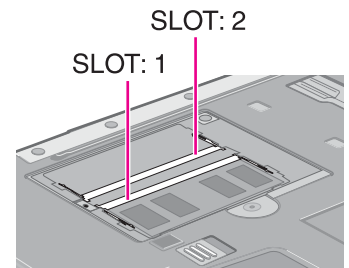

- 1 Turn off the computer.**
  - Do not use standby or hibernation.
- 2 Disconnect the AC adaptor and remove the battery pack (→ page 16).**
- 3 Remove the screws (A) and the cover on the bottom of the computer.**

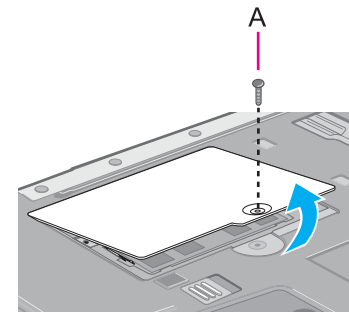

## 4 Insert/Remove the RAM module.

- To insert
  - ① Tilt the module slightly and insert it in the slot.
  - ② Press down the module so that the right and left hooks (B) are locked.
  
- To remove
  - ① Carefully open the right and left hooks (B). The module will rise.
  - ② Carefully remove the module from the slot.

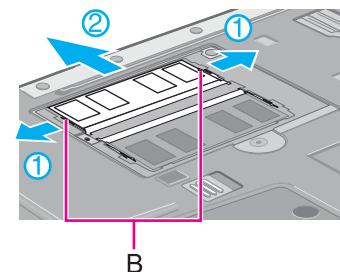
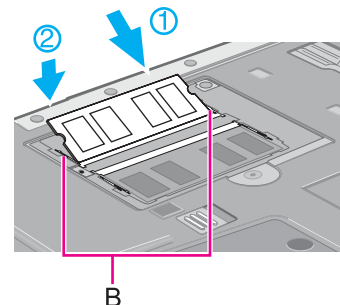

### CAUTION

- Set the cover correctly and tighten screws firmly.

### NOTE

- If it is hard to insert or to press down the RAM module, do not try forcibly but check the module's direction.
  - Use the appropriate screw driver so as not to strip the thread of screw.
  - If the RAM module is recognized correctly, the total size of the main unit memory and RAM module memory is displayed on the [Information] menu of the Setup Utility (→ [page 64](#)).
- If the RAM module is not recognized, power off the computer and insert it again.

You can use an optional port replicator (CF-VEB521 series). This device frees you from being bothered by a lot of cable connections when you carry the computer. It also allows you to connect various peripherals.

Connect the port replicator to the expansion bus connector (A) on the bottom of the computer.

For further information, refer to the instruction manual of the port replicator.

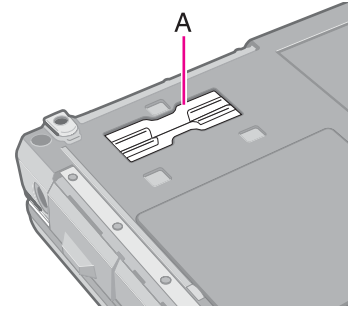

## NOTE

- Use only the specified port replicator (CF-VEB521 series).
- Hot or warm docking/undocking is not possible with the port replicator.

# External Display

You can switch the output destination to an external display.  
Connect the external display to the external display port (A).

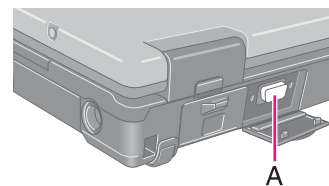

## NOTE

- After resuming from hibernation or restarting the computer, the output destination may not be the same as selected in the previous status.
- When you change the display after Windows starts up, do not press any key until switching is complete.
- You cannot use the simultaneous display until Windows starts up. (Only for model with Mobile Intel® GM965 Express Chipsets)
- Display switching by pressing **Fn+F3** may not work when you use the Fast User Switching function to switch the user. In this case, log off all users and restart the computer.
- Simultaneous display and display switching do not work when [Command Prompt] screen is set to “Full Screen”. (Only for model with Mobile Intel® GM965 Express Chipsets)
- When you use the external display only, set the suitable number of colors, resolution, or refresh rate separately from when you use the internal LCD only or when you use the simultaneous display. Depending on the settings, some external displays may be distorted or may not display the mouse cursor correctly. In this case, set the settings to lower value.
- When you use the simultaneous display, DVD-Video, MPEG files and other motion image files may not be played back smoothly.
- Carefully read the instruction manual of the external display.
- When connecting an external display that does not conform to the Plug & Play standards, select the display driver accordingly in the following menu, or use the driver disc supplied with the monitor.  
[start] - [Control Panel] - [Appearance and Themes] - [Display] - [Settings] - [Advanced] - [Monitor] - [Properties] - [Driver] - [Update Driver]
- If a picture is not displayed normally, lower the level of [Hardware acceleration] in the following menu.  
[start] - [Control Panel] - [Appearance and Themes] - [Display] - [Settings] - [Advanced] - [Troubleshoot]
- If you connect an external display via the port replicator (CF-VEB521 series), the output switches to the port replicator from the external display port.

## CAUTION

- Before disconnecting the external display, switch to the internal LCD by pressing **Fn+F3**. Otherwise the displayed image quality may become different after disconnection (e.g., wrong resolution). In this case, press **Fn+F3** to reset the image quality.
- The screen may become distorted due to the following operations. In this case, restart the computer.
  - Disconnecting an external display for which you have set high resolution or high refresh rate.
  - Connecting/disconnecting an external display during computer operations.

## Switching the Display

### 1 Press **Fn+F3**.

Each time you press the key combination:

Internal LCD → Simultaneous display → External display



## Extended Desktop

The extended desktop function allows you to use the working area across both the internal LCD and the external display. You can drag an object from the internal LCD to the external display and vice versa.

<Only for model with Mobile Intel® PM965 Express Chipsets>

### 1 Click [start] - [Control Panel] - [Appearance and Themes] - [Display] - [Settings].

### 2 Click display [2] and add a check mark for [Extend my Windows desktop onto this monitor], then click [Apply].

If a check mark is already added, remove and add the check mark.

### 3 Make the settings for each display.

### 4 Select [OK].

<Only for model with Mobile Intel® GM965 Express Chipsets>

### 1 Display [Intel(R) Graphics Media Accelerator Driver for mobile] screen.

Click [start] - [Control Panel] - [Other Control Panel Options] - [Intel(R) GMA Driver for Mobile] - [Display Devices].

### 2 Click [Extended Desktop], and make the settings for [Primary Device] and [Secondary Device].

### 3 Click [OK].

At the confirmation message, click [OK].

## NOTE

- It may not be possible to use the extended desktop with some software applications.
- When you click the maximize button, the window is displayed on one of the displays. You cannot move the maximized window to the other display.
- You cannot switch the display by pressing **Fn+F3**.
- The popup menu icon displayed by **Fn** key combination appears only on the primary device.

## Connecting/Removing USB Devices

### Preparation

Before connecting a USB device, first determine the media that contains the device's driver (e.g., CD-ROM), then attach the device for that media to the multimedia pocket. Once the installation screen for the device's driver appears, equipment you then connect to the multimedia pocket will not be recognized.

### ■ To connect the USB device

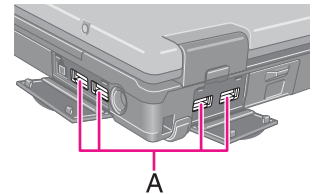

- 1 **Open the cover and connect the USB device to one of the USB ports (A) on the computer.**

For further information, refer to the instruction manual of the USB device.



### ■ To remove the USB device

- 1 **Disable the USB device.**

- ① Double-click  on the notification area and select the USB device, then click [Stop].
- ② Follow the on-screen instructions.
  - This step is not necessary when;
    - Removing the device after turning off the computer.
    -  is not displayed.
    - The device does not appear in the list in step ①.

- 2 **Remove the USB device.**

### NOTE

- You may need to install the driver for the USB device. Follow the on-screen instructions or refer to the instruction manual of the USB device.
- You may need to install the driver again when connecting the device to another port.
- When a USB device is connected, standby and hibernation may not function normally. If the computer does not start up normally, remove the USB device and restart the computer.
- When the USB device is removed and then inserted,  may appear in the Device Manager and the device may not be correctly recognized. In this case, remove and connect the device again.
- When a USB device is connected, power consumption increases. Remove the USB device when it is not in use, especially when operating by battery power.



You can connect a digital video camcorder or other IEEE 1394 standard device to the computer.

## ■ To connect IEEE 1394 devices

### Preparation

Before connecting an IEEE 1394 device, first determine the media that contains the device driver (e.g., CD-ROM), then attach the device for that media to the multimedia pocket. Once the installation screen for the device's driver appears, equipment you then connect to the multimedia pocket will not be recognized.

- 1 Turn on the computer and the IEEE 1394 device.**
- 2 Open the cover and connect the IEEE 1394 device to the IEEE 1394 interface connector (A).**

For further information, refer to the instruction manual of the IEEE 1394 device.

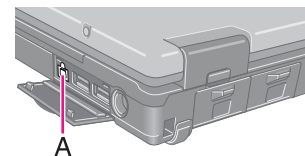

### NOTE

- You may need to install the driver for the IEEE 1394 device. Follow the on-screen instructions or refer to the instruction manual of IEEE 1394 device.

## ■ To remove IEEE 1394 devices

### CAUTION

- Turn off the IEEE 1394 device only after turning off the computer.

- 1 Turn off the computer and disconnect the cable from the IEEE 1394 interface connector.**
- 2 Turn off the IEEE 1394 device and remove the cable.**

## Connecting the Internal Modem with a Telephone Jack

### CAUTION

- You cannot connect the modem to the following lines.
  - Interphone
  - Intercoms
  - ISDN
- Be sure to connect the telephone cable into the modem port, not into the LAN port.
- Use a surge protector since the modem may be damaged by a sudden high voltage surge that may occur in the event of a lightning strike.

**1** Open the cover (A), and connect the computer and the telephone jack (B) using the telephone cable (included) (C).

- Hold the cable so that the shape of the connector (D) matches the port, and insert fully until it clicks.

**2** Click [start] - [Control Panel] - [Printers and Other Hardware] - [Phone and Modem Options] and change the settings as necessary.

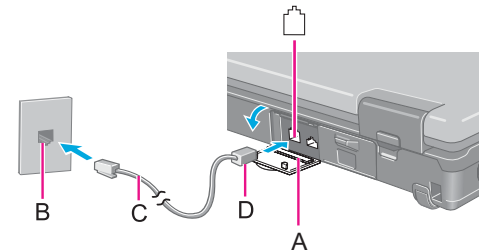

### NOTE

- Do not enter standby or hibernation during communications.
- To remove the cable, press and hold the lever and pull out.

## Ring Resume Function

The computer automatically resumes from standby when the telephone connected to the modem rings. You will need software to keep the computer in idle state waiting for a phone call, and if you prefer, to turn the computer to standby again afterward. For further information, refer to the instruction manual of the software application.

### ■ To enable this function

- 1** Click [start] - [Control Panel] - [Performance and Maintenance] - [System] - [Hardware] - [Device Manager] - [Modems], and double-click the internal modem.
- 2** Click [Power Management], add the check mark for [Allow this device to bring the computer out of standby.], and click [OK].

### ■ To set the time to return the computer to standby

The computer will enter standby after the set time even when the communication is not completed. You can avoid such uncompleted communication if you select [Never], but the computer does not return to standby after resuming by a phone call.

- ① Click [start] - [Control Panel] - [Performance and Maintenance] - [Power Options] - [Power Schemes].
- ② Set the expected communication time.

#### NOTE

- This function does not work when the computer is off or is in hibernation.
- Connect the AC adaptor.
- The screen remains dark after the computer resumes from standby. The previous screen display will be restored when you touch the keyboard or touch pad.
- The computer cannot resume if the telephone is not connected to the internal modem. (e.g., you cannot use a PC Card modem.)
- The computer needs some time to respond, so set the calling time longer than normal. If this is not possible on the transmission side, reduce the number of rings before answering on the software that you are using to keep the computer in idle waiting for the call.

## Connecting LAN

### CAUTION

- Do not connect the telephone cable to the LAN port.

- 1 Turn off the computer.**
  - Do not use standby or hibernation.
- 2 Open the cover (A) and connect the cable.**

Connect the LAN port (B) and the network system (server, HUB, etc.) using a LAN cable.
- 3 Turn on the computer.**

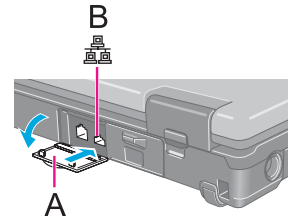

### ■ To check the Local Area Connection status

- ① Click [start] - [Connect To] - [Show all connections].

## Power On by LAN/Wake Up from LAN

### NOTE

- When this function is enabled, power is consumed even the computer is in standby, hibernation, or powered off. Be sure to use the AC adaptor.
- Even when a password is set in the Setup Utility and [Password on boot] is set to [Enable], entering the password is unnecessary for turning on or resuming the computer.
- This function is off under the following conditions:
  - When you turn the computer off by pressing the power switch for four seconds or longer (e.g., after a hung-up).
  - When you reattach the AC adaptor and battery pack to the computer after removing them.
- The screen remains dark after the computer resumes from standby. The previous screen display will be restored when you touch the keyboard or touch pad.

## Enabling the Power On by LAN function

---

The computer automatically turns from off to on when the computer is accessed from the network server via the internal LAN port.

- 1** Select **[Allow]** in **[Power On by LAN]** in the **[Advanced]** menu of the **Setup Utility** (→ [page 66](#)).
- 2** In **[Caution]**, press **Enter**.
- 3** Press **F10**, and then select **[Yes]** and press **Enter**.
- 4** Log on to Windows as an administrator.
- 5** Click **[start]** - **[Control Panel]** - **[Performance and Maintenance]** - **[System]** - **[Hardware]** - **[Device Manager]** - **[Network adapters]** and double-click **[Intel(R) 82566MM Gigabit Network Connection]**, and then click **[Advanced]**.
- 6** Click **[Enable PME]** in **[Property]** and select **[Enabled]** in **[Value]**, and click **[OK]**.

### NOTE

- The computer may accidentally turn on if the linkage status is changed. To prevent the accidental startup, make the setting by the following steps.
    - ① Click **[start]** - **[Control Panel]** - **[Performance and Maintenance]** - **[System]** - **[Hardware]** - **[Device Manager]** - **[Network adapters]**, and double-click **[Intel(R) 82566MM Gigabit Network Connection]**, and then click **[Advanced]**.
    - ② Click **[Wake on Link Settings]** in **[Property]** and select **[Disabled]** in **[Value]**, and click **[OK]**.
  - If you forcibly shut down Windows, the Power ON by LAN function will not work.
-

## Enabling/Disabling the Wake Up from LAN function

---

When the Wake Up from LAN function is enabled, the computer automatically resumes from standby or hibernation when the computer is accessed from the network server via the internal LAN port. (Default setting)

The Wake Up from LAN function can be switched to enable/disable by performing the following procedure.

- 1** Click [start] - [Control Panel] - [Performance and Maintenance] - [System] - [Hardware] - [Device Manager] - [Network adapters] and double-click [Intel(R) 82566MM Gigabit Network Connection], and then click [Power Management].
- 2** Select the setting for [Allow the computer to turn off this device to save power.] and [Allow this device to bring the computer out of standby.], and click [OK].

We recommend you to make the above two settings ON/OFF simultaneously.

### NOTE

---

- The computer may resume when another computer in the network makes unintentional access. Using the following procedure, you can prevent accidental startup by unintentional access.
    - ① Click [start] - [Control Panel] - [Performance and Maintenance] - [System] - [Hardware] - [Device Manager] - [Network adapters] and double-click [Intel(R) 82566MM Gigabit Network Connection], and then click [Power Management].
    - ② Add a check mark for [Only allow management stations to bring the computer out of standby.], and click [OK].
-

## <Only for model with wireless LAN, Bluetooth and/or wireless WAN>

There are three ways of disabling and enabling wireless communication.

- The wireless switch on the front of the computer (below)
- The wireless switch utility (→ [page 56](#))
- Settings in the [Advanced] menu of the Setup Utility (→ [page 66](#))

### NOTE

- For further information about Wireless LAN: → [page 57](#)
- For further information about Bluetooth: → [page 61](#)
- For further information about Wireless WAN: Refer to the instruction manual of the wireless device.

## The Wireless Switch

### ■ To disable all wireless communication

- 1 Switch to OFF.



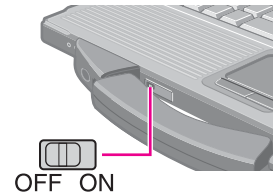

### ■ To enable wireless communication

- 1 Switch to ON.

- In the default setting, the wireless switch enables all wireless devices when it is set to ON.



### NOTE



- If you uninstall the Wireless Switch Utility, set the wireless switch to ON.
- Do not turn on/off the switch repeatedly at too short intervals.
- Do not restart, log off, or enter standby or hibernation immediately after turning on/off the switch.
- Do not turn on/off the switch while Windows is starting up.
- To use wireless communication, set the wireless devices ([Wireless LAN] / [Bluetooth] / [Wireless WAN]) to [Enable] (default) in the [Advanced] menu of the Setup Utility (→ [page 66](#)).
- When you set [Wireless Switch] to [Disable] in the [Advanced] menu of the Setup Utility (→ [page 66](#)), the Wireless Switch Utility icon will not appear in the notification area. All wireless equipment (Wireless LAN, Bluetooth, Wireless WAN) will remain ready irrespective of the wireless switch setting.
- It may take some time to turn off wireless communication after switching the wireless switch off.
- If the IEEE802.11a setting is changed in [Device Manager] (→ [page 59](#)), the display will be changed accordingly.
- You can check the wireless LAN communication status in Intel® PROSet/Wireless Software. Perform either of the following procedures.
  - Double-click , , , or  on the notification area.
  - Click [start] - [All Programs] - [Intel PROSet Wireless] - [Intel PROSet Wireless].

## The Wireless Switch Utility

This utility allows you to control the function of the wireless switch. This utility also allows you to enable or disable wireless devices from a pop-up menu in the notification area. In the default setting, all wireless devices are enabled.

### ■ The Wireless Switch Utility icon

The icon appears in the notification area when the computer is turned ON. It shows the status of wireless devices.

-  : Indicates that the wireless devices are enabled.
-  : Indicates that the wireless devices are off.
-  : Indicates that the wireless devices have been disabled in the Setup Utility.

### ■ To enable or disable particular wireless devices

- 1 Click the Wireless Switch Utility icon to show the pop-up menu
- 2 Select On or Off for the device you want to enable or disable.

### ■ To change the function of the Wireless Switch

In the default setting, the Wireless Switch enables all wireless devices when it is set to ON. You can change this function.

**[Selects the device for which to turn the device status on each time with the dialog box.]**



Display a dialog each time you set the Wireless Switch to ON so you can choose which wireless device to enable.

**[Turns on the following device.] (default)**

Only selected devices are enabled when you set the Wireless Switch to ON.

**[Turns on the device that was on immediately before the wireless switch was turned off the last time.]**

When you turn on the wireless switch, the on/off settings that were selected when you last turned off the wireless switch will be restored.

- 1 Click the Wireless Switch Utility icon ( or ) on the notification area and click [Settings...].
- 2 Select the setting you want to assign to the wireless switch.
- 3 Click [OK].



<Only for model with wireless LAN>

## CAUTION

- **Do not use wireless LAN on airplanes, in hospitals, or in other locations where wireless LAN signals may affect peripheral devices.**  
Follow the instructions of airline companies and hospitals. If you use the computer in these locations, turn off the wireless LAN.
- **To avoid unauthorized access to the computer through wireless LAN**  
We recommend you to make security settings such as encryption before using wireless LAN. Otherwise the hard disk data such as the shared files can be exposed to the risk of unauthorized access.

## NOTE

- Communication is established through the wireless LAN antenna (A). Do not block the antenna area with your hand or body.
- You cannot use the wireless LAN function together with the Fast User Switching function.
- The transmission rate will be lower when a microwave oven is used near by.
- To use wireless LAN, set [Wireless LAN] to [Enable] (default) in the [Advanced] menu of the Setup Utility (→ [page 66](#)).
- It may take some time to turn off wireless LAN after switching the wireless switch to off.

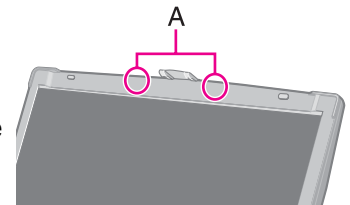

## Using the Wireless LAN Function







Before using a wireless LAN, turn the wireless LAN communication on.

### Turning on/off the wireless LAN communication

- 1 Slide the wireless switch to turn ON / OFF wireless LAN. (→ [page 55](#))

## Setting the profiles

---



- 1** Double-click  /  /  on the notification area.  
The [Intel(R) PROSet/Wireless] screen appears.
  - When  or  is displayed, skip step 2.
- 2** When you double-clicked  in step 1, slide the wireless switch to turn on.
- 3** Click [Profiles] and click [Add].
- 4** Enter the profile name and wireless network name (SSID), and make other necessary changes, then click [Next].
- 5** Make necessary settings and click [OK].
- 6** Select the profile you set and click [Connect].
- 7** Click [Close].

### NOTE



- You need to set the profile for each user.
  - The settings depend on the network environment. For further information, ask the system administrator or the person in charge of the network.
  - For further information of Intel<sup>®</sup> PROSet/Wireless software, refer to [Help] in the menu bar.
-

## Enabling/Disabling the Wireless LAN Standard IEEE802.11a (802.11a)

This section is available for countries except U.S.A. For U.S.A., do not change to [802.11a Enabled].

- 1 Click  or  on the notification area.
- 2 Click [802.11a Enabled] or [802.11a Disabled].



### NOTE

- In some countries, communication using IEEE802.11a (5 GHz wireless LAN) standard is restricted by law.
- The Wireless Switch Utility icon (  or  ) indicates the on/off status of wireless LAN and/or Bluetooth and/or wireless WAN, not the setting of IEEE802.11a.
- If IEEE802.11a is enabled or disabled while the computer is connected to an IEEE802.11b/g access point, the connection will be temporarily interrupted.
- You can also change the IEEE802.11a setting in [Device Manager].
  - ① Click [start] - [Control Panel] - [Performance and Maintenance] - [System] - [Hardware] - [Device Manager].
  - ② Click [Network adapters] and double-click [Intel(R) Wireless WiFi Link 4965AG].
  - ③ Click [Advanced], and then select [Wireless Mode] in [Property].
  - ④ Remove the check mark from [Use default value] in [Value], and select the settings (e.g., [802.11a and 802.11g]).
  - ⑤ Click [OK].





If you enable or disable 802.11a using the popup menu of Wireless Switch Utility, the setting in [Device Manager] will be accordingly changed as below.

Settings in Device Manager	Settings in Wireless Switch Utility	
	When 802.11a is enabled	When 802.11a is disabled
[802.11a, 802.11b and 802.11g] [802.11b and 802.11g]	a+b+g is enabled	b+g is enabled
[802.11g only] [802.11a and 802.11g]	a+g is enabled	g is enabled
[802.11a only] [802.11b only]	a is enabled	b is enabled

## To check the wireless LAN network status

- ① Place the cursor over the Wireless Switch Utility icon (  or  ) on the notification area.  
A tooltip appears.

### NOTE

- The Wireless Switch Utility icons (  and  ) indicate the on/off status of wireless communication, not the IEEE802.11a setting.
- If the setting is changed in [Device Manager], the display will be changed accordingly.
- Perform either of the following procedures to check the status in Intel<sup>®</sup> PROSet/Wireless Software.
  - Double-click ,  or  on the notification area.
  - Click [start] - [All Programs] - [Intel PROSet Wireless] - [Intel PROSet Wireless].

## <Only for model with Bluetooth>

You can access internet and other Bluetooth devices without connecting cables.

### NOTE

- Communication is established through the Bluetooth antenna (A). Do not block the antenna area with your hand or body.
- To use Bluetooth, set [Bluetooth] to [Enable] (default) in the [Advanced] menu of the Setup Utility (→ [page 66](#)).
- The transmission rate will be lower when a microwave oven is used near by.
- It may take some time to turn off Bluetooth after switching the wireless switch to off.
- When you uninstall the Bluetooth Driver, turn Bluetooth off.

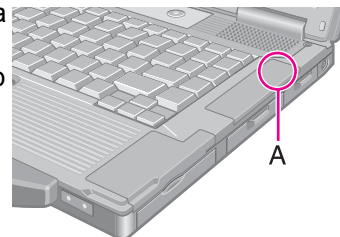



## Using the Bluetooth Function

Before using a Bluetooth, turn the Bluetooth communication on.

### Turning on/off the Bluetooth communication

- 1 Slide the wireless switch to turn ON / OFF Bluetooth. (→ [page 55](#))

## To check the Bluetooth communication status

- ① Place the cursor over the Wireless Switch Utility icon (  or  ) on the notification area. A tooltip appears.

### ■ To access the online manual

- ① Click [start] - [All Programs] - [Bluetooth] - [User's Guide].

## Inserting/Removing the Hard Disk Drive

To change your hard disk drive, contact Panasonic Technical Support.

### CAUTION

- Back up all the important data before removing the hard disk drive.
- If you need to read the hard disk data on another computer for repair or any other purpose, set [Hard Disk Lock] to [Disable] in the [Security] menu of the Setup Utility (→ [page 67](#)) before removing the hard disk drive.
- Carefully remove/insert the hard disk drive since the hard disk drive is extremely sensitive to shock. Note that static electricity may affect some internal components.

### 1 Turn off the computer and disconnect the AC adaptor.

- Do not use standby or hibernation.

### 2 Remove the battery pack (→ [page 16](#)).

### 3 Insert/Remove the hard disk drive.

- To remove  
Slide and hold the latch (A), and slide and lift the cover (B) carefully.  
The hard disk drive is attached behind the cover.  
Slide the cover back.
- To insert  
Insert the hard disk drive until it clicks.

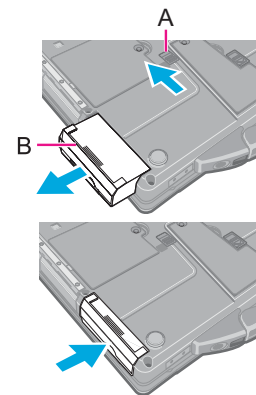

### 4 Insert the battery pack (→ [page 17](#)).

### CAUTION

- Confirm that the latch is surely locked so that the hard disk drive does not fall when you carry the computer.
- Be sure to attach the hard disk drive for use.

### NOTE

- You can erase the data before changing the hard disk drive. (⇒ *Operating Instructions* “Hard Disk Data Erase Utility”)
- You can check that the hard disk is recognized or not in the [Information] menu of the Setup Utility (→ [page 64](#)). If the hard disk is not recognized, turn off the computer and insert it again.

You can make the settings of the computer's operating environment (password settings, startup drive selection, etc.)

## Starting the Setup Utility

- 1 Turn on or restart the computer.
- 2 Press **F2** several times while [Panasonic] boot screen is displayed soon after the computer starts the startup procedure.

When [Enter Password] is displayed, enter your password.

### **When you start the Setup Utility with Supervisor Password**

- You can make the settings of all items of the Setup Utility.

### **When you start the Setup Utility with User Password**

- Note the following:
  - In the [Advanced] and [Boot] menus, you cannot make the settings of all items.
  - In the [Security] menu, you can change only the User Password when [User Password Protection] is set to [No Protection]. You cannot delete the User Password.
  - In the [Exit] menu, you cannot make the setting of [Get Default Values].
  - **F9** (Setup Defaults) does not function.

## Information Menu

Underlined items are the factory presets.

Language	<u>English</u> Japanese
Model No.	Computer information (cannot be changed.)
Serial No.	
CPU Type	
CPU Speed	
BIOS	
Embedded Controller	
System Memory	
Available Memory	
Video RAM	
• Only for model with Mobile Intel® PM965 Express Chipsets	
Hard Disk	
Optical Drive	
Accumulative Operating Time	



## Main Menu

Underlined items are the factory presets.

System Time <ul style="list-style-type: none"> <li>• 24-hr. style.</li> <li>• You can use <b><u>Tab</u></b> to move the cursor.</li> </ul>	[xx:xx:xx]
System Date <ul style="list-style-type: none"> <li>• Month/Day/Year.</li> <li>• You can use <b><u>Tab</u></b> to move the cursor.</li> </ul>	[xx/xx/xxxx]
Touch Pad	Disable <u>Enable</u>
Display <ul style="list-style-type: none"> <li>• The display during the Windows start-up process. When an external display is not connected, the information appears on the internal LCD even though an external monitor is selected.</li> </ul>	<Only for model with Mobile Intel® PM965 Express Chipsets> External Monitor Internal LCD <u>Simultaneous</u>
	<Only for model with Mobile Intel® GM965 Express Chipsets> <u>External Monitor</u> Internal LCD
DVD Drive Speed	<u>High</u> Low
Environment	Normal Temperature High Temperature <u>Auto</u>
Current Status <ul style="list-style-type: none"> <li>• Only when [Environment] is set to [Auto].</li> </ul>	Depending on the battery status, either “Normal Temperature” or “High Temperature” is displayed.

## Advanced Menu

Underlined items are the factory presets.

Core Multi-Processing	Disable <u>Enable</u>
Intel(R) Virtualization Technology	<u>Disable</u> Enable
Serial Port	Disable <u>Enable</u>
Smart card • Only for model with Smart Card slot	Disable <u>Enable</u>
Modem	Disable <u>Enable</u>
LAN	Disable <u>Enable</u>
Power On by LAN • Can be changed only when [LAN] is set to [Enable]. • To use [Power On by LAN], make additional settings in [Device Manager] ( <a href="#">→ page 52</a> )	<u>Deny</u> Allow
Wireless LAN • Only for model with wireless LAN	Disable <u>Enable</u>
Wireless WAN • Only for model with wireless WAN	Disable <u>Enable</u>
Bluetooth • Only for model with Bluetooth	Disable <u>Enable</u>
Wireless Switch	Disable <u>Enable</u>
PC Card Slot	Disable <u>Enable</u>
ExpressCard Slot	Disable <u>Enable</u>
SD Slot	Disable <u>Enable</u>
USB Port	Disable <u>Enable</u>
Legacy USB Support	Disable <u>Enable</u>

## Security Menu

Underlined items are the factory presets.

Execute-Disable Bit Capability <ul style="list-style-type: none"> <li>• [Enable] indicates that this computer supports hardware-based Data Execution Prevention (DEP).</li> </ul>	Disable <u>Enable</u>
Password on boot	Disable <u>Enable</u>
SD Startup <ul style="list-style-type: none"> <li>• Only when [Password on boot] is set to [Enable] and one or more SD card is registered.</li> </ul>	<u>Disable</u> Enable
SD Setting Method <ul style="list-style-type: none"> <li>• Only when [SD Startup] is set to [Enable]</li> </ul>	<u>Leave Set</u> Set and Eject
▶ Clear registered SD card <ul style="list-style-type: none"> <li>• Only when one or more SD card is registered.</li> </ul>	Enter the sub-menu.
▶ Set Supervisor Password	Enter the sub-menu.
Setup Utility Prompt <ul style="list-style-type: none"> <li>• When [Setup Utility Prompt] is set to [<u>Disable</u>], the message “Press F2 for Setup / F12 for LAN” is not displayed on [Panasonic] boot screen. However, <b><u>F2</u></b> and <b><u>F12</u></b> will work even if the message is not displayed.</li> </ul>	Disable <u>Enable</u>
Boot First Menu	Disable <u>Enable</u>
Hard Disk Lock	<u>Disable</u> Enable
User Password Protection	<u>No Protection</u> Protected
▶ Set User Password	Enter the sub-menu.
DVD Operation	Disable <u>Enable</u>
▶ Embedded Security (TPM) Sub-Menu <ul style="list-style-type: none"> <li>• For information on TPM, refer to the <i>Installation Manual</i> of “Trusted Platform Module (TPM)”. Click [start] - [Run] and input [c:\util\drivers\tpm\readme.pdf], and click [OK].</li> </ul>	Enter the sub-menu.
▶ Fingerprint Security Sub-Menu <ul style="list-style-type: none"> <li>• Only for model with Fingerprint Reader</li> </ul>	Enter the sub-menu.
▶ Computrace (R) Sub-Menu	Enter the sub-menu.

## Boot Menu

```
Boot priority order:
1: USB FDD:*1
2: Hard Disk: xxxxxxxxxx
3: Optical Drive: xxxxxxxxxx
4: PCI LAN: xxxxxxxxxx
5:
6:
7:
8:
Excluded from boot order: *2
: USB KEY:
: USB HDD:
: USB CDD:
: USB LS120:
```

\*<sup>1</sup> Use the Panasonic USB floppy disk drive (optional: CF-VFDU03U)

\*<sup>2</sup> The devices under [Excluded from boot order] are not booted.

### ■ To change the boot order

To move up, select the device with ↑ and ↓, and then press **F6**.

To move down, select the device with ↑ and ↓, and then press **F5**.

To move the device from [Excluded from boot order] to [Boot priority order] or vice versa, select the device with ↑ and ↓, and then press **X**.

To return to the default setting, press **I**.

#### NOTE

- The default order is [USB FDD] -> [Hard Disk] -> [Optical Drive] -> [PCI LAN].
- To boot from the following devices, confirm the settings as below.

##### To boot from

##### You need to set

- USB connected device : [USB Port] and [Legacy USB Support] to [Enable] (→ [page 66](#))
- LAN : [LAN] to [Enable] (→ [page 66](#))
- Multimedia pocket device : [DVD Operation] to [Enable] (→ [page 67](#))

- You can select the boot device during start-up of the computer, too. Press **Esc** soon after [Panasonic] boot screen is displayed. [Boot Menu] appears and you can select the device. [Boot Menu] appears only when [Boot First Menu] in the [Security] menu is set to [Enable] (→ [page 67](#)). When you change the setting in the [Boot] menu, [Boot Menu] will be changed accordingly.

## Exit Menu

Save Values & Exit	To save the changes to CMOS and reboot.
Exit Without Saving Changes	To exit without saving the changes to CMOS.
Get Default Values	To return the settings to the default values.
Load Previous Values	To load the previous values from CMOS.
Save Current Values	To save the changes to CMOS.

## Enlarging the screen items

You can enlarge the screen items such as characters, icons, title bars and mouse cursor.

### CAUTION

- “Icon Enlarger” will not start up if the display resolution is set lower than 1024 x 768 dots.

### NOTE

- A part of the enlarged menu or some screen items may be hidden. In this case, overlay the cursor to display pop-ups, scroll the screen, or use other functions to display the hidden items.
- The Icon Enlarger setting affects the website characters displayed by Internet Explorer and the e-mail characters in Outlook Express. Some characters of website and e-mail may not be enlarged.

### Preparation

Close all of the applications before using “Icon Enlarger”.

- 1 Click [start] - [All Programs] - [Panasonic] - [Icon Enlarger].**
- 2 Select the size.**
- 3 Click [OK].**

The screen will be displayed in the selected size.

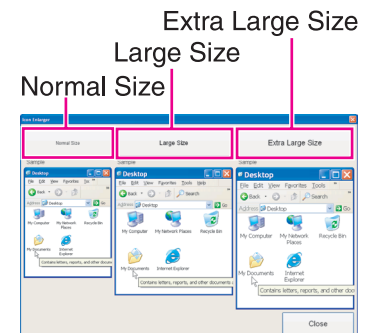



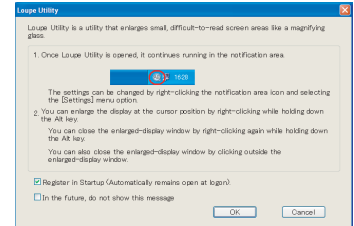

You can magnify the specific part of the screen.

## Activating the Loupe Utility

- 1 Click [start] - [All Programs] - [Panasonic] - [Loupe Utility].
- 2 Click [OK].
  -  appears on the notification area.



## Using the Loupe Utility

- 1 Point the cursor  at the part of the screen you want to magnify.
- 2 Press and hold **Alt**, and right-click.
  - The part pointed by the cursor is magnified.
  - Alternatively you can double-click , or right-click  and click [Show Loupe].
- 3 Drag the loupe window (A) to move the magnified part.
  - To hide the loupe window, click the Hide button  (B).
  - Alternatively you can click any part out of the loupe window, or press and hold **Alt** and right-click.
  - To change the loupe window size, drag the bottom-right corner (C).  
The size range you can enlarge/shrink depends on the screen's resolution.

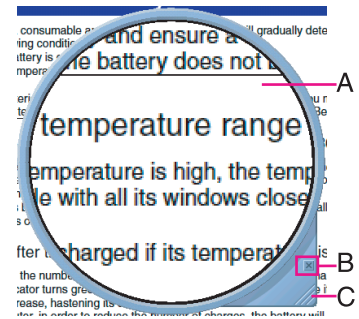

## NOTE

- The magnified text or image in the loupe window is fixed at the moment that the part is magnified (e.g., at the moment you press and hold **Alt** and right-click). To reflect the change you made on the original screen to the loupe window, click the loupe window.
- The Loupe Utility does not work with some applications.

## Setting the Loupe Utility

1 Right-click  on the notification area.



2 Click [Settings].

### [Show/hide shortcuts assignment]

- When using the external mouse/touch pad
  - ① Click [Mouse / Touch pad]
  - ② Click a combination of **Alt**, **Ctrl**, and **Shift**, and add the check mark. (Multiple keys can be combined; for example, **Ctrl** + **Alt** )
  - ③ Click either [Right click] or [Left click] to use in combination with the key(s) selected in ② above.
- When using the keyboard
  - ① Click [Keyboard].
  - ② Click the text box and then press the key used for the shortcut. (e.g., **Alt** + **Z**, **Ctrl** + **Alt** + **Z**, etc.)

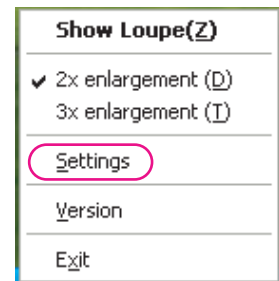

### [Window shape]

Select the shape of the loupe window.

### [Autorun]

Add a check mark to run the Loupe Utility when Windows starts up.

### [Restore Defaults]

Click to restore the default settings.

3 Click [OK].



This computer conforms to the specifications of the Desktop Management Interface (DMI). You can use the DMI Viewer to access the computer's information including the CPU, memory and supported system.

**1 Click [start] - [All Programs] - [Panasonic] - [DMI Viewer].**

The DMI Viewer screen appears.

**2 Click the item to display the detailed information.**

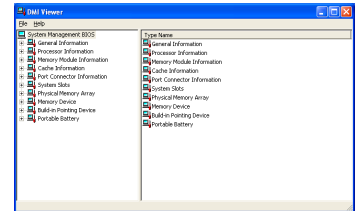

■ **To save the information as a text file**

① **To save the item that is displayed**

Click [File] - [Save Selected Data...].

**To save all items**

Click [File] - [Save All Data...].

② Select the folder, input the file name, then click [Save].

Recover Pro is a data backup software application developed by Phoenix Technologies Ltd. It provides 3 types of backup as follows:

- Quick Backup: Scheduled backup of the updated data
- File Backup: File backup at file save and change
- Complete Backup: Backup of the entire data on the internal hard disk

For further information, refer to the software's online manual.

## Installing Recover Pro

**1 Log on to Windows as an administrator.**

**2 Close all the applications.**

- Disable antivirus software

**3 Click [start] - [Run...] and input [c:\util\rcvpro\setup.exe], and click [OK].**

Follow the on-screen instructions.

- After the computer restarts, Recover Pro starts initialization. Do not touch keys or switch including hot key, during initialization until an instruction message appears.

### CAUTION

- Be sure to use the internal hard disk drive to create the backup area. Never use disk or device other than the internal hard disk drive.
- Some software (security software, backup software, encryption software, or hard disc accessible specific software, etc.) may be incompatible with Recover Pro.  
For further information, refer to:  
<http://www.phoenix.com/en/Customer+Services/White+Papers-Specs/Recover+Pro/default.htm>
- When using Personal Secure Drive (refer to the *Installation Manual* of "Trusted Platform Module (TPM)"), do not execute File Backup for Personal Secure Drive.

### NOTE

- If you select [Typical] in installation, approximately 40% (max.) of the hard disk drive space is allocated as the backup area.
- You cannot change the size of backup area after creation.

## ■ To access the online manual

- ① Click [start] - [All Programs] - [Phoenix Applications] - [Docs], and double-click [UserGuides].
- ② Double-click the file of Recover Pro user's guide or Phoenix Always user's guide.

## Network Connections and Communications Software

Close the communications software before using the power saving function.

- If the power saving function (standby or hibernation) is activated while communications software is used, the network connection may be interrupted, or the performance may be adversely affected. In this case, restart the computer.
- In a network environment, set the [System standby] and [System hibernates] settings to [Never].  
Click [start] - [Control Panel] - [Performance and Maintenance] - [Power Options] - [Power Schemes].

## Using the Windows Associated Files

The Windows files included in the retail version of the Windows CD-ROM for OS are contained in the following folders:

c:\windows\docs, c:\windows\dotnetfx, c:\windows\i386, c:\windows\support, c:\windows\valueadd

Refer to the following instructions when a problem occurs. If the remedies indicated in the chart do not solve the problem, contact Panasonic Technical Support. For a software problem, refer to the instruction manual of the software.

- To check the computer's usage status (→ [page 84](#)).

## ■ Shut Down

Cannot shut down or restart Windows.	<ul style="list-style-type: none"><li>● Remove USB devices.</li><li>● It may take one or two minutes to shut down.</li></ul>
--------------------------------------	--



## ■ Standby/Hibernation

Cannot enter standby or hibernation.	<ul style="list-style-type: none"><li>● Remove USB devices temporarily. If the problem persists, restart the computer.</li><li>● It may take one or two minutes to enter standby or hibernation.</li><li>● The computer may not enter standby when the computer is communicating via modem.</li><li>● The computer does not enter standby or hibernation immediately after resuming. Wait approximately one minute.</li><li>● When a disc formatted using B's CLiP is in the CD/DVD drive, the computer will not enter standby or hibernation. Remove the disc.</li></ul>
Cannot enter standby or hibernation automatically.	<ul style="list-style-type: none"><li>● Disconnect peripheral devices.</li><li>● When a disc formatted using B's CLiP is in the CD/DVD drive, the computer will not enter standby or hibernation. Remove the disc.</li></ul>
The computer does not resume.	<ul style="list-style-type: none"><li>● If you press and hold the power switch for four seconds or longer, the power will be turned off forcibly and the computer will not resume. In this case, all unsaved data will be lost.</li><li>● You disconnected the AC adaptor and the battery pack while the computer was in standby mode. If the computer's power supply is disconnected in standby mode, unsaved data will be lost and the computer will not resume.</li><li>● The battery is exhausted. Standby and hibernation consume some power.</li></ul>
The computer will not automatically enter standby/hibernation mode.	<ul style="list-style-type: none"><li>● If you connect to a network using wireless LAN function, select the profile and connect to the access point (→ <a href="#">page 58</a>).</li><li>● If you do not use wireless LAN function, turn off wireless LAN function (→ <a href="#">page 57</a>).</li><li>● Make sure that you are not using any software that regularly accesses the hard disk.</li></ul>

## ■ Sound

No sound.	<ul style="list-style-type: none"> <li>● Press <b>Fn+F4</b> or <b>Fn+F6</b> to cancel mute.</li> </ul>
Distorted sound.	<ul style="list-style-type: none"> <li>● Performing <b>Fn</b> key combinations sometimes causes sound distortion. Stop and restart playback.</li> </ul>
Cannot change the volume by pressing <b>Fn+F5</b> or <b>Fn+F6</b> .	<ul style="list-style-type: none"> <li>● Activate the Windows sound function. When it is not active, the volume does not change even if  is displayed.</li> </ul>
“There was an error updating the registry” appears when Sound Recorder is started.	<ul style="list-style-type: none"> <li>● Sound Recorder is started by a limited account user whose language setting is not the same as the administrator user who last started Sound Recorder. This does not affect the operation.</li> </ul>

## ■ Keyboard

Only numbers can be input.	<ul style="list-style-type: none"> <li>● When the indicator  is on, the keyboard is in ten-key mode. Press <b>NumLk</b> to cancel.</li> </ul>
Only capital letters can be input.	<ul style="list-style-type: none"> <li>● When the indicator  is on, the keyboard is in Caps Lock mode. Press <b>Caps Lock</b> to cancel.</li> </ul>
Cannot enter special characters (ß, à, ç, etc.) and symbols.	<ul style="list-style-type: none"> <li>● Use the character map. Click [start] - [All Programs] - [Accessories] - [System Tools] - [Character Map].</li> </ul>

## ■ Disc Operation

The CD/DVD drive does not work normally.	<ul style="list-style-type: none"> <li>● Set [DVD Operation] to [Enable] in the [Security] menu of the Setup Utility (→ <a href="#">page 67</a>).</li> <li>● Clean the lens (→ <a href="#">page 20</a>).</li> <li>● Check the disc condition (→ <a href="#">page 21</a>).</li> </ul>
Cannot play back TV programs recorded on a commercial DVD recorder.	<ul style="list-style-type: none"> <li>● Finalize the disc on the DVD recorder when the program was recorded in video mode on DVD-R/RW or in VR mode on DVD-RW.</li> </ul>
A blue background appears on the screen when playing an MPEG image.	<ul style="list-style-type: none"> <li>● You opened the CD/DVD drive or removed the MPEG disc while it was operating. Re-insert the MPEG disc and close the CD/DVD drive.</li> </ul>
The CD/DVD drive vibrates excessively or makes noise.	<ul style="list-style-type: none"> <li>● Insert the disc correctly.</li> <li>● Check the disc condition (→ <a href="#">page 21</a>).</li> <li>● Set [DVD Drive Speed] to [Low] in the [Main] menu of the Setup Utility (→ <a href="#">page 65</a>).</li> <li>● When writing to a CD using B's Recorder, set the writing speed at [8x] or less.</li> </ul>



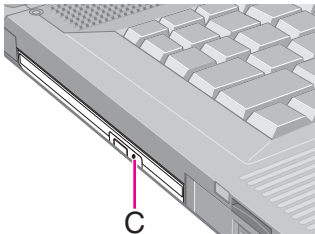



## ■ Disc Operation

Cannot eject a disc.	<ul style="list-style-type: none"> <li>● Turn on the computer. To remove a disc when the computer is powered off, insert a pointed object (e.g., the bent-out tip of a paper clip, or the tip of a pencil or ballpoint pen) into the emergency hole (A). Pushing it completely to the end will free the tray so that it can be pulled out. (The position of the emergency hole differs depending on the drive.)</li> </ul>	
The disc tray does not close.	<ul style="list-style-type: none"> <li>● Do not touch the eject button when closing the tray.</li> </ul>	
Other disc operation problems.	<ul style="list-style-type: none"> <li>● Use another drive or media.</li> </ul>	

## ■ Network

Cannot connect to a network.	<ul style="list-style-type: none"> <li>● Set [LAN] / [Modem] to [Enable] in the [Advanced] menu of the Setup Utility (→ <a href="#">page 66</a>).</li> </ul>
Cannot check the computer's MAC address.	<ul style="list-style-type: none"> <li>● Follow the steps below. <ol style="list-style-type: none"> <li>① Click [start] - [All Programs] - [Accessories] - [Command Prompt].</li> <li>② Input [ipconfig /all], and press <b>Enter</b>.</li> <li>③ Write down the 12-digit string of alphanumeric displayed in the "Physical Address" line of the LAN or the wireless LAN (only for model with wireless LAN).</li> <li>④ Input [exit], and press <b>Enter</b>.</li> </ol> </li> </ul>

## ■ Wireless Communication (Only for model with wireless LAN/Bluetooth/wireless WAN)

Cannot connect to network.	<ul style="list-style-type: none"> <li>● Slide the wireless switch to turn on the wireless devices.</li> <li>● Set the device ([Modem] / [Wireless LAN] / [Bluetooth] / [Wireless WAN]) to [Enable] in the [Advanced] menu of the Setup Utility (→ <a href="#">page 66</a>).</li> <li>● Restart the computer.</li> </ul>
Access point is not detected.	<ul style="list-style-type: none"> <li>● Confirm that  /  /  is displayed on the notification area. If  /  /  is not displayed on the notification area, turn on the wireless communication.</li> </ul>

## ■ Connecting Peripherals

<p>An error occurs while installing the driver.</p>	<ul style="list-style-type: none"> <li>● When you install a driver of card or peripheral device, make sure that the driver is compatible with the operating system. If it is not compatible, malfunction may occur. For information about the driver, contact the manufacturer of the peripheral device.</li> <li>● Before connecting peripheral equipment, first determine the media that contains the peripheral device's driver (e.g., CD-ROM), then attach the device for that media to the multimedia pocket. Once the installation screen for the device's driver appears, equipment you then connect to the multimedia pocket will not be recognized.</li> </ul>
<p>A peripheral device does not work.</p>	<ul style="list-style-type: none"> <li>● Install the driver.</li> <li>● Contact the manufacturer of the device.</li> <li>● When operation resumes from standby or hibernation, devices such as a mouse, modem and PC Card may not function properly. In this case, restart the computer or reinitialize the device.</li> <li>● When  is displayed in the Device Manager, remove and insert the device. If the problem persists, restart the computer.</li> <li>● When you set [USB Port] to [Disable] in the [Advanced] menu of the Setup Utility (→ page 66), USB ports of port replicator are also disabled.</li> <li>● The computer may not recognize the connection/removal of some devices, or may not operate normally with some devices.             <ol style="list-style-type: none"> <li>① Click [start] - [Control Panel] - [Performance and Maintenance] - [System] - [Hardware] - [Device Manager].</li> <li>② Select the device and remove the check mark for [Allow the computer to turn off this device to save power] in [Power Management]. (This item may be unavailable for some types of devices.)</li> </ol> </li> </ul>
<p>The connected mouse does not work.</p>	<ul style="list-style-type: none"> <li>● Check the mouse connection.</li> <li>● Install the driver compatible with the connected mouse. If the mouse does not work even after installing the driver, set [Touch Pad] to [Disable] in the [Main] menu of the Setup Utility (→ page 65).</li> </ul>
<p>USB floppy disk drive does not work as a boot drive.</p>	<ul style="list-style-type: none"> <li>● You can use only the Panasonic CF-VFDU03U USB floppy disk drive (optional).</li> <li>● Remove the floppy disk drive from the multimedia pocket.</li> <li>● Set [USB Port] and [Legacy USB Support] to [Enable] in the [Advanced] menu of the Setup Utility (→ page 66).</li> <li>● Move up [USB FDD] to the top of [Boot priority order] in the [Boot] menu of the Setup Utility (→ page 68).</li> <li>● Turn off the computer and connect the USB floppy disk drive, and then restart the computer.</li> </ul>

## ■ Connecting Peripherals

The RAM module is not recognized.	<ul style="list-style-type: none"><li>● Insert the RAM module correctly.</li><li>● Use the compatible RAM module (→ page 42).</li><li>● Check the [Information] menu in the Setup Utility (→ page 64). If the RAM module is not recognized, turn off the computer and reinsert the RAM module.</li></ul>
You do not know the address map for IRQ, I/O port address, etc.	<ul style="list-style-type: none"><li>● To check the current address map, click [start] - [Control Panel] - [Performance and Maintenance] - [System] - [Hardware] - [Device Manager] - [View] - [Resources by type].</li></ul>
The device connected to the serial port does not work.	<ul style="list-style-type: none"><li>● Check the connection.</li><li>● The device driver may not work. Refer to the instruction manual of the device.</li><li>● Do not connect two mouse devices simultaneously.</li><li>● Set [Touch Pad] to [Disable] in the [Main] menu of the Setup Utility (→ page 65).</li><li>● Set [Serial Port] to [Enable] in the [Advanced] menu of the Setup Utility (→ page 66).</li></ul>
Cannot print.	<ul style="list-style-type: none"><li>● Check the printer connection.</li><li>● Turn on the printer.</li><li>● The printer is not online.</li><li>● No paper is in the printer tray or there is a paper jam.</li><li>● Turn on the printer and connect it to the computer, and then restart the computer.</li><li>● Check the network connection if the printer is connected via network.</li></ul>



## ■ Connecting Peripherals

<p>LAN transmission speed slows down noticeably.          Poor performance during data transmission via a PC Card (e.g., distorted video image when writing to a DV camera using an IEEE1394 PC Card).          &lt;Only for model with wireless LAN&gt;          Wireless LAN connection is cut.</p>	<ul style="list-style-type: none"> <li>● These problems may occur due to performance loss that results from the CPU power-saving function. Log on to Windows as an administrator and follow the steps below.             <ol style="list-style-type: none"> <li>① Click [start] - [Run] and input [c:\util\cpupower\setup.exe], and click [OK].                  Follow the on-screen instructions.</li> <li>② Click [start] - [All Programs] - [Panasonic] - [CPU Idle Setting].</li> <li>③ Click [Performance] and click [OK], then click [Yes].                  The computer is restarted automatically.                 <ul style="list-style-type: none"> <li>● If the problem persists, click [start] - [Control Panel] - [Performance and Maintenance] - [Power Options] - [Power Schemes], select [Always On] in [Power schemes], and click [OK].</li> </ul> </li> </ol> </li> <li>● The above remedy is effective for performance loss resulting from the CPU power saving function, but not for other causes (e.g., noise generated by high CPU load such as video playback).</li> <li>● The above remedy slightly reduces the battery operation time. Normally it is recommended to select [Battery (Windows XP Standard)] in [CPU Idle Setting] and to select [Portable/Laptop] in [Power schemes].</li> </ul>
---	---

## ■ Touch Pad

<p>The cursor does not work.</p>	<ul style="list-style-type: none"> <li>● Connect the external mouse correctly.</li> <li>● Restart the computer using the keyboard.              (Press <b>F12</b>, <b>U</b>, and <b>R</b> to select [Restart].)</li> <li>● If the computer does not respond to keyboard commands, read “No response” (→ <a href="#">page 83</a>).</li> </ul>
<p>Cannot input using the touch pad.</p>	<ul style="list-style-type: none"> <li>● Set [Touch Pad] to [Enable] in the [Main] menu of the Setup Utility (→ <a href="#">page 65</a>).</li> <li>● The drivers for some mice may disable the touch pad. Check your mouse’s operating instructions.</li> </ul>

## ■ PC Card / ExpressCard (only for model with ExpressCard slot)

A card does not work.	<ul style="list-style-type: none"><li>● Insert the card correctly.</li><li>● The card does not conform to the card standard.</li><li>● Restart the computer after installing a driver (of card or other device).</li><li>● Set [PC Card Slot] and [ExpressCard Slot] to [Enable] in the [Advanced] menu of the Setup Utility (→ <a href="#">page 66</a>).</li><li>● The port settings are not correct.</li><li>● Read the instruction manual of the card or contact the manufacturer of the card.</li><li>● Remove the card and insert it again (→ <a href="#">page 32</a>).</li><li>● The driver is not compatible with the operating system.</li></ul>
-----------------------	--

## ■ SD Memory Card

Cannot use an SD Memory Card.	<ul style="list-style-type: none"><li>● Set [SD Slot] to [Enable] in the [Advanced] menu of the Setup Utility (→ <a href="#">page 66</a>).</li><li>● This computer does not support SDHC Memory Card (SD Memory Card with the capacity of 4GB or more).</li></ul>
Cannot use SD security function.	<ul style="list-style-type: none"><li>● Setup the SD Memory Card (→ <a href="#">page 37</a>).</li><li>● You cannot use SD security together with fingerprint security (optional).</li></ul>
Cannot log on using the SD Memory Card.	<ul style="list-style-type: none"><li>● The user name and password set in the SD Memory Card are not correct. Enter the correct user name and password, and log on to Windows without using the SD Memory Card. Set the correct user name and password in [SD Card Setup] (→ <a href="#">page 37</a>).</li></ul>

## ■ Smart Card (only for model with Smart Card slot)

Cannot use a Smart Card.	<ul style="list-style-type: none"><li>● Insert the Smart Card correctly.</li><li>● Set [Smart card] to [Enable] in the [Advanced] menu of the Setup Utility (→ <a href="#">page 66</a>).</li><li>● To use a Smart Card, you need a special software and driver.</li></ul>
--------------------------	---

## ■ Fast User Switching Function

<p>Some applications do not work properly.</p>	<ul style="list-style-type: none"><li>● When switching to a different user with the Fast User Switching function, the following problems may occur.<ul style="list-style-type: none"><li>• Some applications may not work properly.</li><li>• Key combination with <b>Fn</b> may not work.</li><li>• The display settings may not be possible.</li><li>• A serial mouse may not work.</li><li>• The B's CLiP icon does not appear on the notification area and disc writing is not possible.</li><li>• &lt;Only for model with wireless LAN&gt; Wireless LAN cannot be used.</li><li>• &lt;Only for model with Bluetooth&gt; Bluetooth cannot be used.</li></ul></li></ul> <p>In these cases, log off all users without using Fast User Switching function and perform the operation once more. If the problem persists, restart the computer.</p>
--	--

## ■ Others

<p>No response.</p>	<ul style="list-style-type: none"><li>● Press <b>Ctrl+Shift+Esc</b> to open Task Manager and close the software application.</li><li>● An input screen (e.g., password input screen at startup) may be hidden behind another window. Use <b>Alt+Tab</b> to check.</li><li>● Shut down by pressing the power switch for four seconds or longer, and turn on the computer and open the application again. If it no longer works normally, delete and reinstall it. Click [start] - [Control Panel] - [Add or Remove Programs].</li></ul>
<p>A motion image file cannot be played using Windows® Media Player and the message [Codec required] appears.</p>	<ul style="list-style-type: none"><li>● Some motion image files require a Codec that is not installed as standard. In this case, connect to the Internet and try playback of the file again. The Codec may automatically be downloaded so you may be able to play it.</li></ul>

## Checking the Computer's Usage Status

You can check the computer's usage status in the PC Information Viewer. You may need this information when calling Panasonic Technical Support for advice.

### NOTE

- This computer periodically records the management information including the hard disk information such as number of hours powered-on, number of times powered-on, internal temperature, replacement sector. The maximum data volume for each record is 750 byte. These information are only used for estimating the cause when the hard disk goes down by any possibility. They are never sent to outside via network nor used for any other purpose except for the purpose described the above.  
To disable the function, add the check mark for [Disable the automatic save function for management information history] in [Hard Disk Status] of PC Information Viewer, and click [OK].
- As long as it is activated, the PC Information Viewer will appear in front of all other screens.

- 1** Click [start] - [All Programs] - [Panasonic] - [PC Information Viewer] - [PC Information Viewer].
- 2** Select the item to display the detailed information.

### ■ To save the information as a text file

- ① Display the information you want to save.
  - ② Click [Save].
  - ③ Select the file save range option and click [OK].
  - ④ Select the folder to save the information, input the file name, and click [Save].
- If automatic saving of the management information record has not been disabled, the records already recorded are also saved.

### ■ To save a copy of the screen as an image file

- ① Display the screen you want to save.
- ② Press **Ctrl+Alt+F8**.
- ③ When the screen copy message appears, click [OK].  
The screen image is saved in [My Documents] folder.
  - Alternatively you can save a copy of the screen in the following procedure.  
Click [start] - [All Programs] - [Panasonic] - [PC Information Viewer] - [Screen Copy].

## NOTE

- The image is a bitmap file in 256 colors.
- When using the extended desktop (→ [page 46](#)), a copy of the primary device screen is saved.
- The default key combination to copy is **Ctrl+Alt+F8**. You can change it in the following procedure.
  - ① Log on to Windows as an administrator.
  - ② Click [start] - [All Programs] - [Panasonic] - [PC Information Viewer].
  - ③ Right-click [Screen Copy] and click [Properties] - [Shortcut].
  - ④ Click [Shortcut key] and press the key(s) you want to use for the shortcut.
  - ⑤ Click [OK].

- Copyright

This manual is copyrighted by Matsushita Electric Industrial Co., Ltd. with all rights reserved. No part of this manual may be reproduced in any form without the prior written permission of Matsushita Electric Industrial Co., Ltd. No patent liability is assumed with respect to the use of the information contained herein.

© 2007 Matsushita Electric Industrial Co., Ltd. All Rights Reserved.

- Disclaimer

Computer specifications and manuals are subject to change without notice. Matsushita Electric Industrial Co., Ltd. assumes no liability for damage incurred directly or indirectly from errors, omissions or discrepancies between the computer and the manuals.

- Trademarks

- Microsoft, Windows and the Windows logo are registered trademarks of Microsoft Corporation of the United States and/or other countries.
- Intel, Core, Viiv, Centrino and PROSet are either registered trademarks or trademarks of Intel Corporation.

- SD Logo is a trademark.



- Adobe, the Adobe logo and Adobe Reader are either registered trademarks or trademarks of Adobe Systems Incorporated in the United States and/or other countries.
- PhoenixBIOS, Phoenix Always and Recover Pro are trademarks and/or registered trademarks of Phoenix Technologies Ltd.
- Bluetooth™ is a trademark owned by Bluetooth SIG, Inc., U.S.A. and licensed to Matsushita Electric Industrial Co., Ltd.
- WinDVD™ is a trademark of InterVideo, Inc.
- Panasonic is a registered trademark of Matsushita Electric Industrial Co., Ltd.
- Names of products, brands, etc., appearing in this manual are trademarks or registered trademarks of their respective own companies.