

Dell Vostro 15–3565 Owner's Manual

Regulatory Model: P47F
Regulatory Type: P47F006



Notes, cautions, and warnings

 **NOTE:** A NOTE indicates important information that helps you make better use of your computer.

 **CAUTION:** A CAUTION indicates either potential damage to hardware or loss of data and tells you how to avoid the problem.

 **WARNING:** A WARNING indicates a potential for property damage, personal injury, or death.

© 2016 Dell Inc. All rights reserved. This product is protected by U.S. and international copyright and intellectual property laws. Dell and the Dell logo are trademarks of Dell Inc. in the United States and/or other jurisdictions. All other marks and names mentioned herein may be trademarks of their respective companies.

2016 - 04

Rev. A00

Contents

1 Working on your computer.....	7
Safety instructions.....	7
Before working inside your computer.....	8
Turning off your computer.....	8
Turning off your computer – Windows 10.....	8
Turning off your computer – Windows 7.....	9
After working inside your computer.....	9
2 Chassis view.....	10
Front open view.....	10
Front closed view.....	10
Rear view.....	11
Right view.....	11
Left view.....	12
3 Removing and installing components.....	13
Recommended tools.....	13
Removing the battery.....	13
Installing the battery.....	14
Removing the optical drive	14
Removing the optical drive bracket.....	14
Installing the optical drive bracket.....	15
Installing the optical drive.....	15
Removing the keyboard.....	15
Installing the keyboard.....	17
Removing the base cover.....	17
Installing the base cover.....	18
Removing the hard drive assembly.....	19
Removing the hard drive from the hard drive bracket.....	19
Installing the hard drive into the hard drive bracket.....	20
Installing the hard drive assembly.....	20
Removing the memory module.....	20
Installing the memory module.....	21
Removing the coin cell battery.....	21
Installing the coin cell battery.....	22
Removing the WLAN card.....	22
Installing the WLAN card.....	23
Removing the Input/Output board	23

Installing the Input/Output board	24
Removing the speakers.....	24
Installing the speakers.....	25
Removing the heat sink assembly.....	25
Installing the heat sink assembly.....	26
Removing the system board.....	26
Installing the system board.....	28
Removing the power connector.....	29
Installing the power connector.....	30
Removing the display assembly.....	30
Installing the display assembly.....	32
Removing the display bezel.....	32
Installing the display bezel.....	33
Removing the camera.....	33
Installing the camera.....	34
Removing the display panel.....	35
Installing the display panel.....	36
Removing the display hinges.....	36
Installing the display hinges.....	37

4 Technology and components..... 39

Power adapter.....	39
Processors.....	39
Identifying processors in Windows 10.....	39
Identifying processors in Windows 7.....	39
Verifying the processor usage in Task Manager.....	39
Verifying the processor usage in Resource Monitor.....	40
Chipsets.....	41
Downloading the chipset driver.....	41
Identifying the chipset in Device Manager on Windows 10.....	41
Identifying chipset in Device Manager on Windows 7.....	41
Graphic chipset.....	42
AMD chipset drivers.....	42
AMD Radeon Graphics drivers.....	43
Display options.....	43
Identifying the display adapter.....	43
Changing the screen resolution.....	43
Rotating the display.....	44
Adjusting brightness in Windows 10.....	44
Adjusting brightness in Windows 7.....	44
Cleaning the display.....	44
Connecting to external display devices.....	45

Audio options.....	45
Downloading the audio driver.....	45
Realtek ALC3234–CG Waves MaxxAudio Pro controller.....	45
Downloading the audio driver.....	45
Identifying the audio controller in Windows 10.....	46
Identifying the audio controller in Windows 7.....	46
Realtek HD audio drivers.....	46
WLAN card.....	46
Hard drive options.....	47
Identifying the hard drive in Windows 10.....	47
Identifying the hard drive in Windows 7.....	47
Entering BIOS setup.....	47
Camera features.....	47
Identifying the camera in Device Manager on Windows 10.....	47
Identifying the camera in Device Manager on Windows 7.....	47
Starting the camera.....	47
Starting the Camera App.....	48
Memory features.....	49
Verifying system memory in Windows 10.....	49
Verifying system memory in Windows 7.....	49
Verifying system memory in setup.....	49
Testing memory using ePSA.....	49
5 System Setup.....	51
Boot Sequence.....	51
Navigation keys.....	51
Navigation keys.....	51
Setup Utility options.....	52
Main screen option.....	52
Advanced screen option.....	53
Security screen option.....	54
Boot.....	54
Exit.....	55
Updating the BIOS	55
System and setup password.....	56
Assigning a system password and setup password.....	56
Deleting or changing an existing system and/or setup password.....	57
6 Enhanced Pre-Boot System Assessment (ePSA) diagnostics.....	58
Running the ePSA diagnostics.....	58
7 Technical specifications.....	59

System specifications.....	59
Processor specifications.....	59
Memory specifications.....	59
Audio specifications.....	59
Video specifications.....	60
Camera specifications.....	60
Communication specifications.....	60
Port and connector specifications.....	60
Display specifications.....	61
Keyboard specifications.....	61
Touchpad specifications.....	61
Battery specifications.....	62
AC Adapter specifications.....	62
Physical specifications.....	62
Environmental specifications.....	63
8 Contacting Dell.....	64

Working on your computer

Safety instructions

Use the following safety guidelines to help protect your computer from potential damage and to help to ensure your personal safety. Unless otherwise noted, each procedure included in this document assumes that the following conditions exist:

- You have read the safety information that shipped with your computer.
- A component can be replaced or--if purchased separately--installed by performing the removal procedure in reverse order.

 **WARNING: Disconnect all power sources before opening the computer cover or panels. After you finish working inside the computer, replace all covers, panels, and screws before connecting to the power source.**

 **WARNING: Before working inside your computer, read the safety information that shipped with your computer. For additional safety best practices information, see the Regulatory Compliance Homepage at www.dell.com/regulatory_compliance**

 **CAUTION: Many repairs may only be done by a certified service technician. You should only perform troubleshooting and simple repairs as authorized in your product documentation, or as directed by the online or telephone service and support team. Damage due to servicing that is not authorized by Dell is not covered by your warranty. Read and follow the safety instructions that came with the product.**

 **CAUTION: To avoid electrostatic discharge, ground yourself by using a wrist grounding strap or by periodically touching an unpainted metal surface, such as a connector on the back of the computer.**

 **CAUTION: Handle components and cards with care. Do not touch the components or contacts on a card. Hold a card by its edges or by its metal mounting bracket. Hold a component such as a processor by its edges, not by its pins.**

 **CAUTION: When you disconnect a cable, pull on its connector or on its pull-tab, not on the cable itself. Some cables have connectors with locking tabs; if you are disconnecting this type of cable, press in on the locking tabs before you disconnect the cable. As you pull connectors apart, keep them evenly aligned to avoid bending any connector pins. Also, before you connect a cable, ensure that both connectors are correctly oriented and aligned.**

 **NOTE: The color of your computer and certain components may appear differently than shown in this document.**

Before working inside your computer

To avoid damaging your computer, perform the following steps before you begin working inside the computer.

1. Ensure that you follow the [Safety instructions](#).
2. Ensure that your work surface is flat and clean to prevent the computer cover from being scratched.
3. Turn off your computer (see [Turning off your computer](#)).
4. If the computer is connected to a docking device (docked), undock it.

 **CAUTION:** To disconnect a network cable, first unplug the cable from your computer and then unplug the cable from the network device.

5. Disconnect all network cables from the computer.
6. Disconnect your computer and all attached devices from their electrical outlets.
7. Close the display and turn the computer upside-down on a flat work surface.

 **NOTE:** To avoid damaging the system board, you must remove the main battery before you service the computer.

8. Remove the main battery.
9. Turn the computer top-side up.
10. Open the display.
11. Press the power button to ground the system board.

 **CAUTION:** To guard against electrical shock, always unplug your computer from the electrical outlet before opening the display.



 **CAUTION:** Before touching anything inside your computer, ground yourself by touching an unpainted metal surface, such as the metal at the back of the computer. While you work, periodically touch an unpainted metal surface to dissipate static electricity, which could harm internal components.

12. Remove any installed ExpressCards or Smart Cards from the appropriate slots.

Turning off your computer

Turning off your computer — Windows 10

 **CAUTION:** To avoid losing data, save and close all open files and exit all open programs before you turn off your computer.

1. Click or tap .
2. Click or tap  and then click or touch **Shut down**.

 **NOTE:** Ensure that the computer and all attached devices are turned off. If your computer and attached devices did not automatically turn off when you shut down your operating system, press and hold the power button for about 6 seconds to turn them off.

Turning off your computer — Windows 7

 **CAUTION:** To avoid losing data, save and close all open files and exit all open programs before you turn off your computer.

1. Click **Start**.
2. Click **Shut Down**.

 **NOTE:** Ensure that the computer and all attached devices are turned off. If your computer and attached devices did not automatically turn off when you shut down your operating system, press and hold the power button for about 6 seconds to turn them off.

After working inside your computer

After you complete any replacement procedure, ensure that you connect external devices, cards, and cables before turning on your computer.

 **CAUTION:** To avoid damage to the computer, use only the battery designed for this particular Dell computer. Do not use batteries designed for other Dell computers.

1. Connect any external devices, such as a port replicator or media base, and replace any cards, such as an ExpressCard.
2. Connect any telephone or network cables to your computer.

 **CAUTION:** To connect a network cable, first plug the cable into the network device and then plug it into the computer.

3. Replace the battery.
4. Connect your computer and all attached devices to their electrical outlets.
5. Turn on your computer.

Chassis view

Front open view



- 1. Touchpad
- 2. Camera
- 3. Camera status light
- 4. Microphone
- 5. Power button
- 6. Keyboard

Front closed view



- 1. Power and battery status light

Rear view

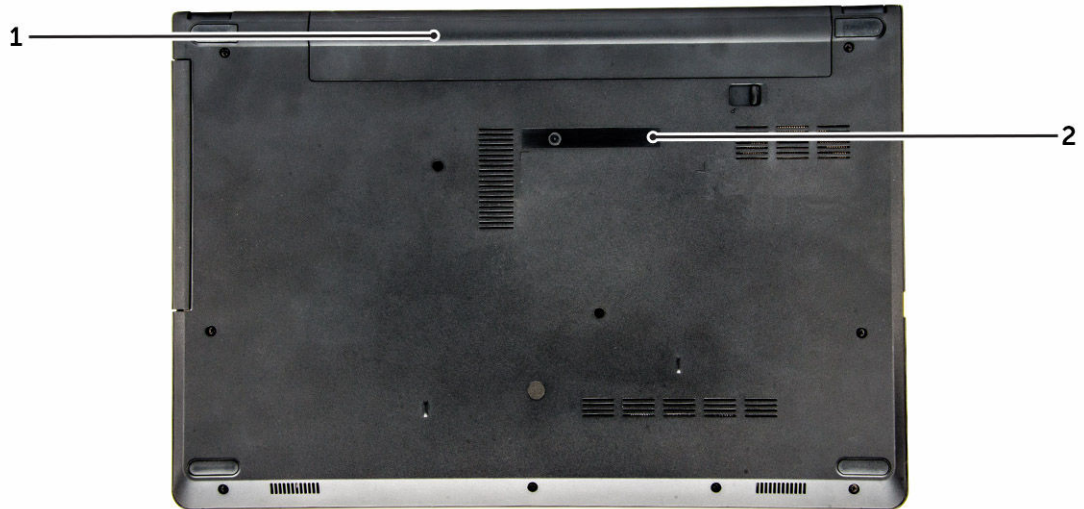

1. Battery

2. Service Tag label

Right view



1. Headset connector

2. USB 2.0 connector

3. USB 2.0 connector

4. Optical drive

5. Security cable slot

Left view

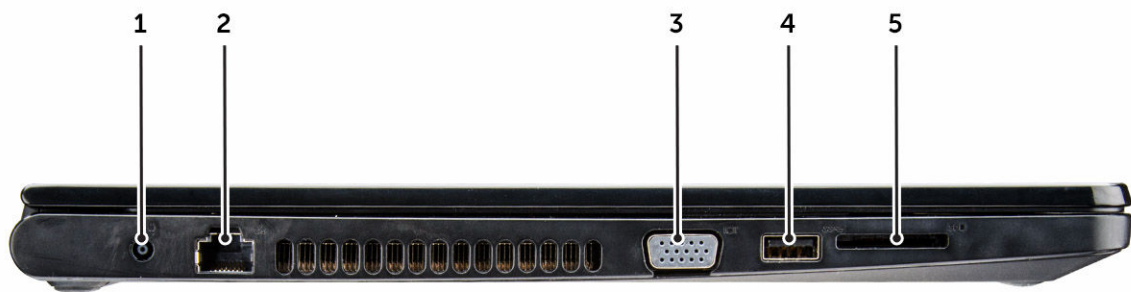

- | | |
|-----------------------|----------------------|
| 1. Power connector | 2. Network connector |
| 3. VGA connector | 4. USB 3.0 connector |
| 5. Memory card reader | |

Removing and installing components

This section provides detailed information on how to remove or install the components from your computer.

Recommended tools

The procedures in this document require the following tools:

- Small flat blade screwdriver
- Phillips #0 screwdriver
- Phillips #1 screwdriver
- Small plastic scribe

Removing the battery

1. Follow the procedure in [Before working inside your computer](#).
2. To remove the battery:
 - a. Slide the release latch to unlock the battery [1].
 - b. Remove the battery from the computer [2].

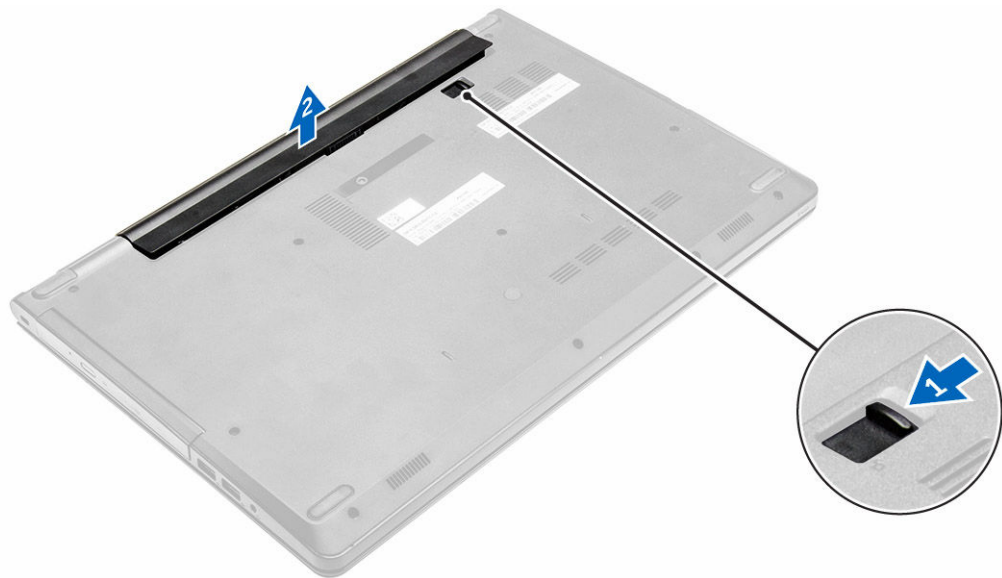

Installing the battery

1. Insert the battery into the slot and press it until it clicks into place.
2. Follow the procedures in [After working inside your computer](#).

Removing the optical drive

1. Follow the procedure in [Before working inside your computer](#).
2. Remove the [battery](#).
3. To remove the optical drive:
 - a. Remove the screw that secures the optical drive to the computer [1].
 - b. Using a plastic scribe push the tab to release the optical drive [2].
 - c. Slide the optical drive out of the computer [3].

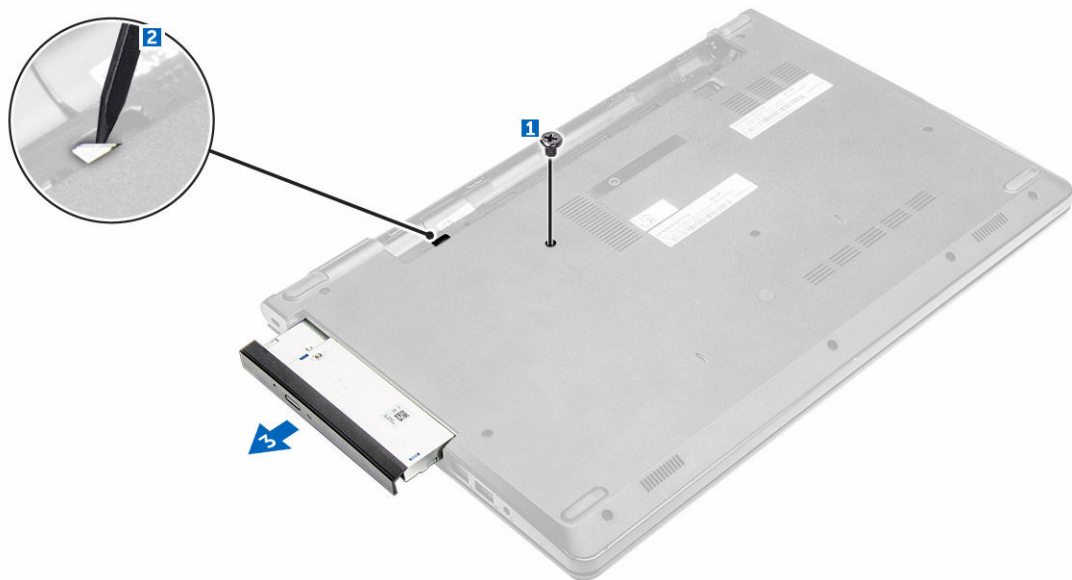

Removing the optical drive bracket

1. Follow the procedure in [Before working inside your computer](#).
2. Remove the:
 - a. [battery](#)
 - b. [optical drive](#)
3. To remove the optical drive from bracket:
 - a. Remove the screw that secures the optical drive bracket [1].
 - b. Remove the optical drive bracket from the optical drive [2].

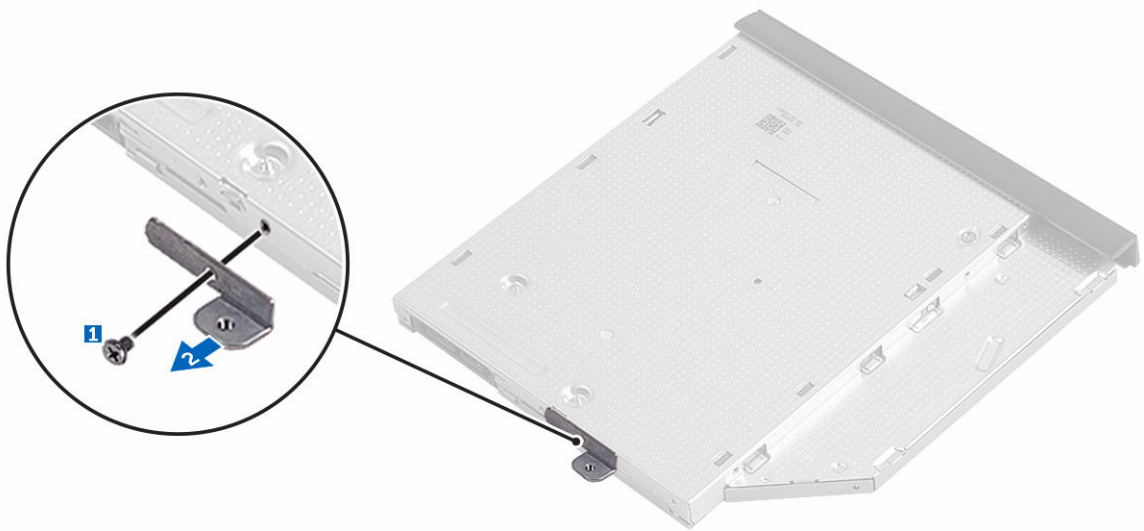

Installing the optical drive bracket

1. Install the optical drive bracket.
2. Tighten the screw to secure the optical drive bracket.
3. Install the:
 - a. [optical drive](#)
 - b. [battery](#)
4. Follow the procedure in [After working inside your computer](#).

Installing the optical drive

1. Insert the optical drive into the slot until it clicks into place.
2. Tighten the screw to secure the optical drive to the computer.
3. Install the [battery](#).
4. Follow the procedure in [After working inside your computer](#).

Removing the keyboard

1. Follow the procedure in [Before working inside your computer](#).
2. Remove the [battery](#).
3. To remove the keyboard:
 - a. Release the keyboard by prying on the keyboard release tabs by using a scribe.



- b. Slide and lift the keyboard to access the keyboard connector cable under the keyboard [1,2].



- 4. To remove the keyboard cable:
 - a. Disconnect the keyboard cable from the system board [1].
 - b. Lift the keyboard cable to remove it from the computer [2].



Installing the keyboard

1. Connect the keyboard cable to the connector on the system board.
2. Slide the keyboard into the retention slots.
3. Press along the top edges to lock the keyboard in place.
4. Install the [battery](#).
5. Follow the procedure in [After working inside your computer](#).

Removing the base cover

1. Follow the procedure in [Before working inside your computer](#).
2. Remove the:
 - a. [battery](#)
 - b. [optical drive](#)
 - c. [keyboard](#)
3. To remove the base cover:
 - a. Disconnect the optical drive connector and lift it to remove it from the system board [1,2].
 - b. Remove the screws inside the palmrest [3].

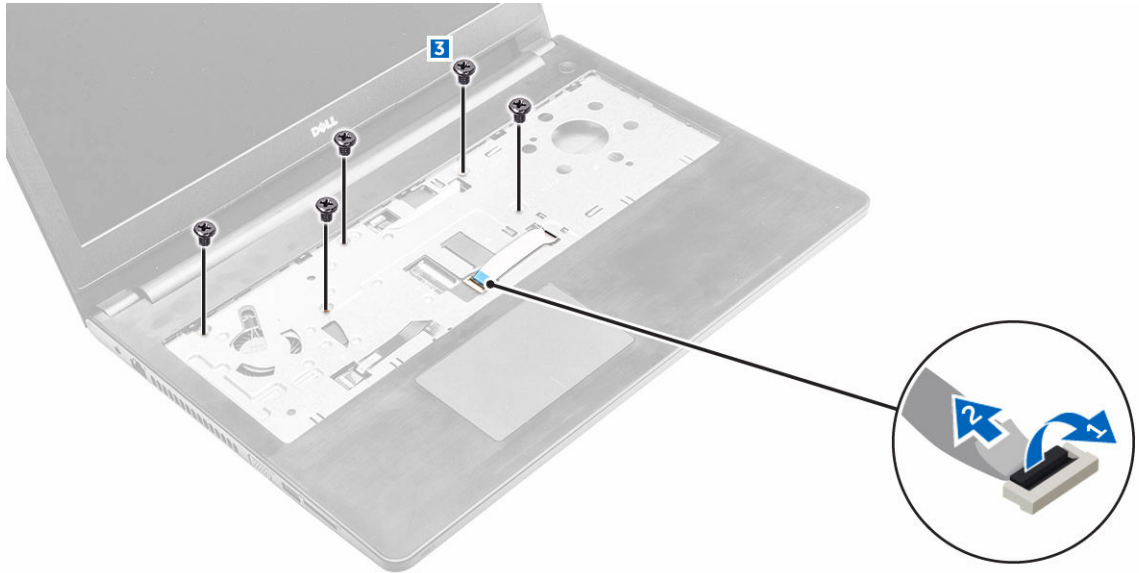

4. To remove the base cover:
 - a. Remove the screws that secure the base cover to the computer [1].
 - b. Pry the edges of base cover and lift it to remove it from computer [2].

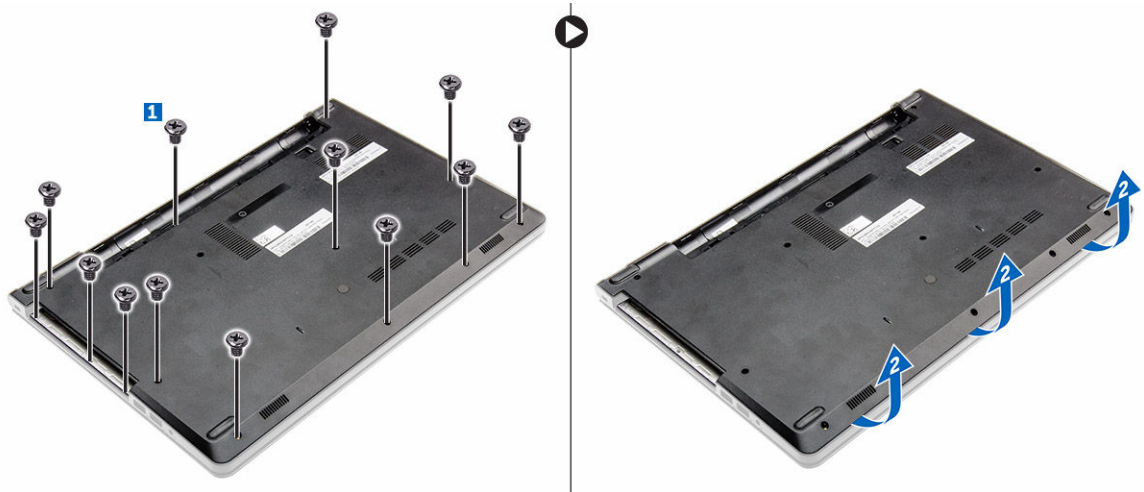

Installing the base cover

1. Align the base cover with the screw holders on the computer.
2. Press the edges of the cover until it clicks into place.
3. Tighten the screws to secure the base cover to the computer.
4. Turn the computer over.
5. Open the computer and connect the optical drive connector to the system board.
6. Tighten the screws to secure the base cover to the palmrest.
7. Install the:
 - a. [keyboard](#)

- b. [optical drive](#)
- c. [battery](#)
8. Follow the procedure in [After working inside your computer](#).

Removing the hard drive assembly

1. Follow the procedure in [Before working inside your computer](#).
2. Remove the:
 - a. [battery](#)
 - b. [optical drive](#)
 - c. [keyboard](#)
 - d. [base cover](#)
3. To remove the hard drive assembly:
 - a. Disconnect the hard drive cable from the connector on the system board [1, 2].
 - b. Remove the screws that secure the hard drive assembly to the computer [3].
 - c. Lift the hard drive assembly away from the computer [4].

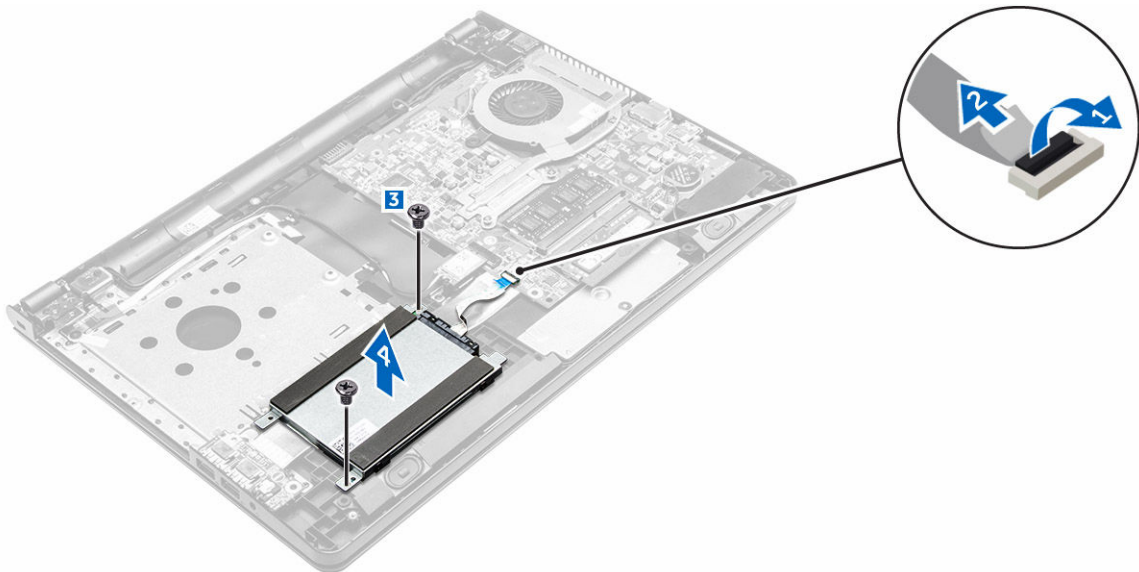

Removing the hard drive from the hard drive bracket

1. Follow the procedure in [Before working inside your computer](#).
2. Remove the:
 - a. [battery](#)
 - b. [optical drive](#)
 - c. [keyboard](#)
 - d. [base cover](#)
 - e. [hard drive assembly](#)
3. To remove the hard drive from hard drive assembly:
 - a. Pull the hard drive cable connector to remove it from the hard drive [1].
 - b. Remove the screws that secure the hard drive bracket to the hard drive [2].

- c. Lift the hard drive from the hard drive bracket [3].

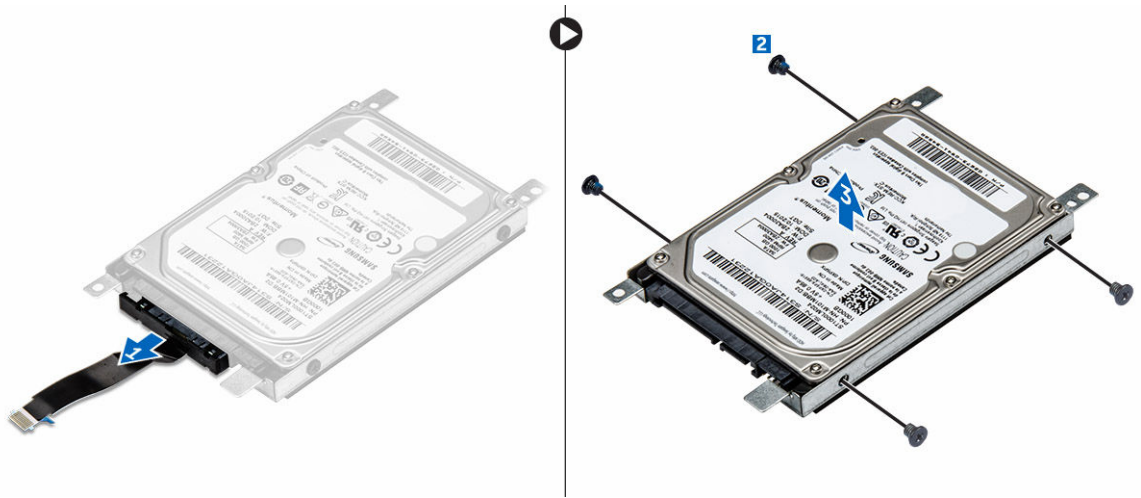

Installing the hard drive into the hard drive bracket

1. Align the screw holders and insert the hard drive into the hard drive bracket.
2. Tighten the screws to secure the hard drive to the hard drive bracket.
3. Connect the hard drive cable connector to the hard drive.
4. Install the:
 - a. [hard drive assembly](#)
 - b. [base cover](#)
 - c. [keyboard](#)
 - d. [optical drive](#)
 - e. [battery](#)
5. Follow the procedure in [After working inside your computer](#)

Installing the hard drive assembly

1. Insert the hard drive assembly into the slot on the computer.
2. Tighten the screws to secure the hard drive assembly to the computer.
3. Connect the hard drive cable to the connector on the system board.
4. Install the:
 - a. [base cover](#)
 - b. [optical drive](#)
 - c. [keyboard](#)
 - d. [battery](#)
5. Follow the procedures in [After working inside your computer](#).

Removing the memory module

1. Follow the procedure in [Before working inside your computer](#).
2. Remove the:

- a. [battery](#)
 - b. [optical drive](#)
 - c. [keyboard](#)
 - d. [base cover](#)
3. To remove memory module:
- a. Pull the clips securing the memory module until the memory module pops up [1].
 - b. Remove the memory module from the system board [2].

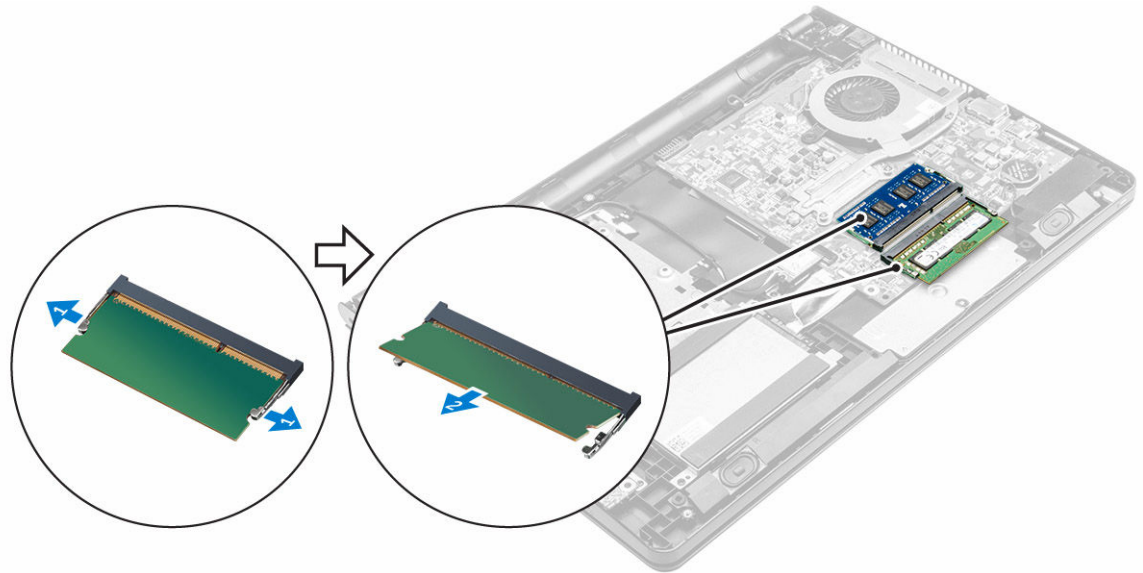

Installing the memory module

1. Insert the memory module into the memory socket.
2. Press the memory module until the clips secure the memory module.
3. Install the:
 - a. [base cover](#)
 - b. [keyboard](#)
 - c. [optical drive](#)
 - d. [battery](#)
4. Follow the procedures in [After working inside your computer](#).

Removing the coin cell battery

1. Follow the procedure in [Before working inside your computer](#).
2. Remove the:
 - a. [battery](#)
 - b. [optical drive](#)
 - c. [keyboard](#)
 - d. [base cover](#)
3. By using a plastic scribe, lift the battery out of the battery slot.

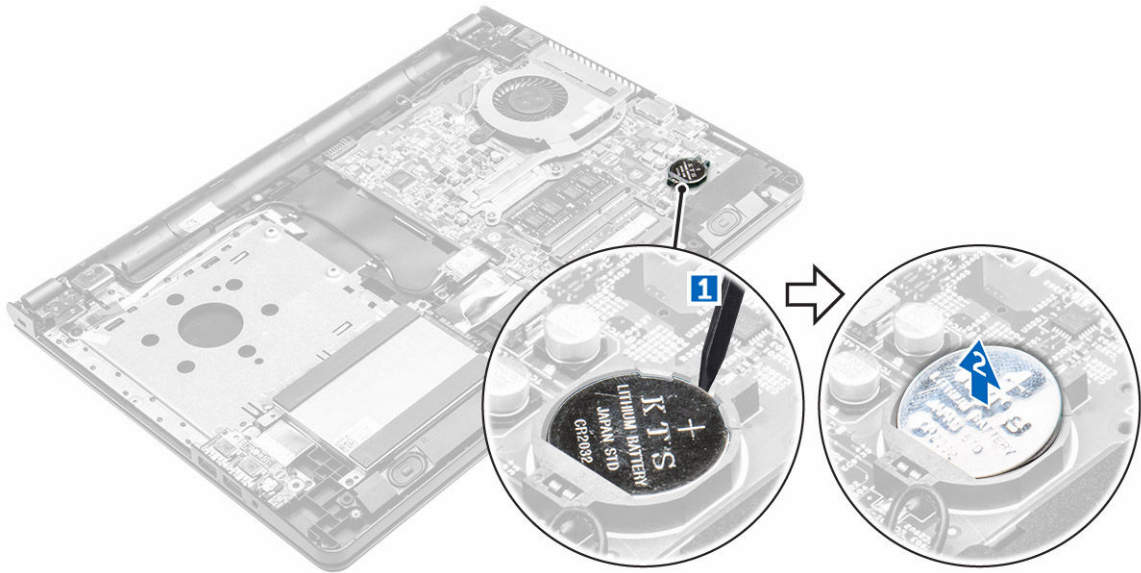

Installing the coin cell battery

1. Insert the coin cell battery into the battery slot.
2. Press the battery until it clicks into place.
3. Install the:
 - a. [base cover](#)
 - b. [keyboard](#)
 - c. [optical drive](#)
 - d. [battery](#)
4. Follow the procedures in [After working inside your computer](#).

Removing the WLAN card

1. Follow the procedure in [Before working inside your computer](#).
2. Remove the:
 - a. [battery](#)
 - b. [optical drive](#)
 - c. [keyboard](#)
 - d. [base cover](#)
3. To remove the WLAN card:
 - a. Disconnect the WLAN cables from the connectors on the WLAN card [1].
 - b. Remove the secure that secures the WLAN card to the system board [2].
 - c. Remove the WLAN card from the computer [3].

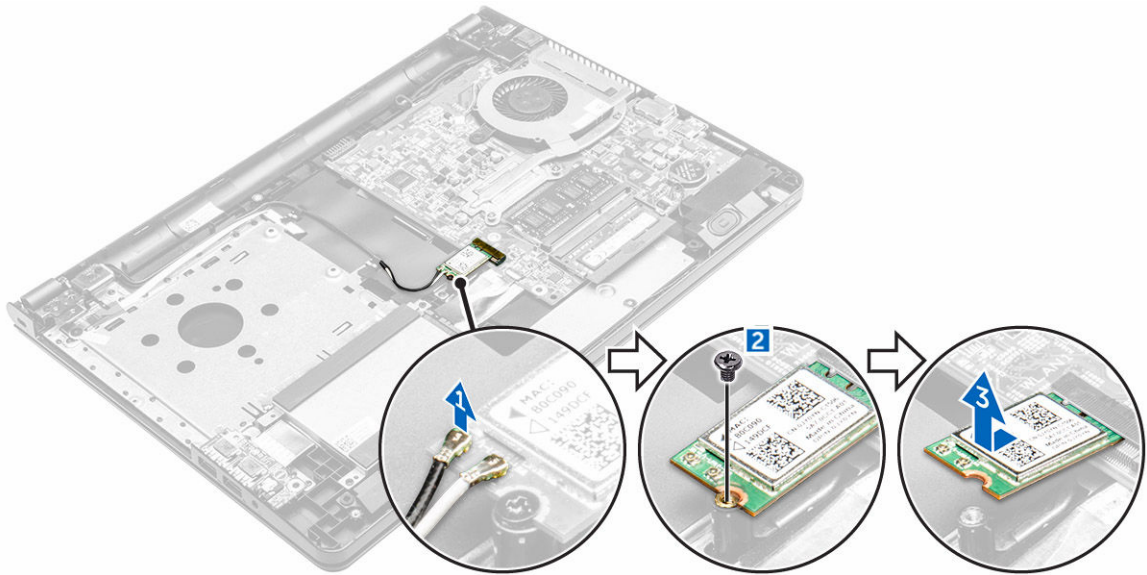

Installing the WLAN card

1. Insert the WLAN card into the slot on the computer.
2. Tighten the screw to secure the WLAN card to the computer.
3. Connect the WLAN cables to the connectors on the WLAN card.
4. Install the:
 - a. [base cover](#)
 - b. [keyboard](#)
 - c. [optical drive](#)
 - d. [battery](#)
5. Follow the procedure in [After working inside your computer](#).

Removing the Input/Output board

1. Follow the procedure in [Before working inside your computer](#).
2. Remove the:
 - a. [battery](#)
 - b. [optical drive](#)
 - c. [keyboard](#)
 - d. [base cover](#)
3. To remove the Input/Output board (I/O board):
 - a. Remove the screw that secures the I/O board to the computer [1].
 - b. Lift the I/O board [2].
 - c. Turn the I/O board over to remove the black adhesive tape that secures the I/O board cable [3].
 - d. Disconnect the I/O board cable [4, 5].

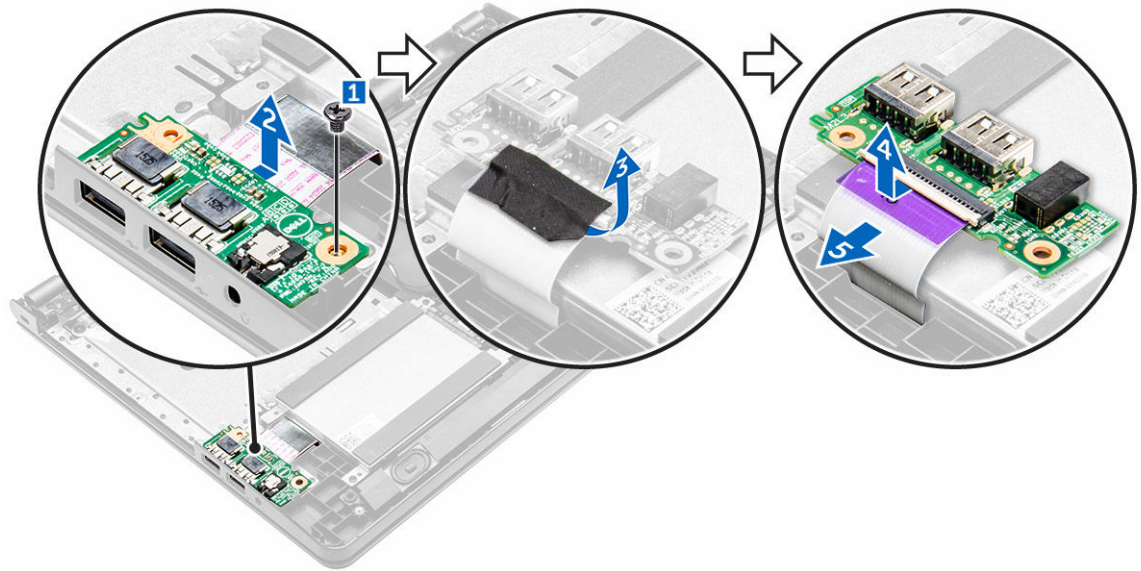

Installing the Input/Output board

1. Connect the input/output (I/O board) cable to the I/O board.
2. Replace the black adhesive tape to secure the i/o board cable.
3. Turn the I/O board over and align it with the screw holder on the computer.
4. Insert the I/O board into the computer.
5. Tighten the screw to secure the I/O board to the computer.
6. Install the:
 - a. [base cover](#)
 - b. [keyboard](#)
 - c. [optical drive](#)
 - d. [battery](#)
7. Follow the procedure in [After working inside your computer](#).

Removing the speakers

1. Follow the procedure in [Before working inside your computer](#).
2. Remove the:
 - a. [battery](#)
 - b. [optical drive](#)
 - c. [keyboard](#)
 - d. [base cover](#)
3. To remove the speakers:
 - a. Disconnect the speaker cable [1].
 - b. Unroute the cables and remove the speakers from the computer [2].

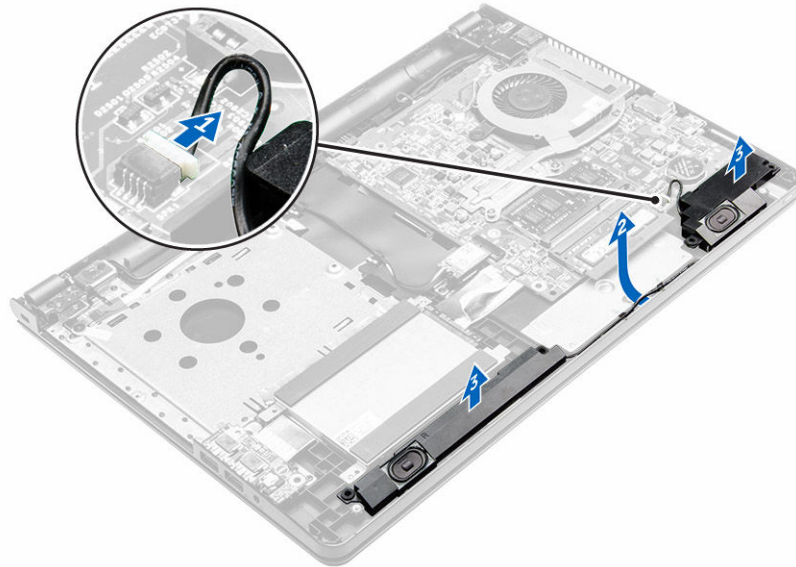

Installing the speakers

1. Insert the tabs on the speakers into the slots on the computer.
2. Route the speaker cable through the routing channel on the computer.
3. Connect the speaker cable to the system board.
4. Install the:
 - a. [base cover](#)
 - b. [keyboard](#)
 - c. [optical drive](#)
 - d. [battery](#)
5. Follow the procedure in [After working inside your computer](#)

Removing the heat sink assembly

1. Follow the procedure in [Before working inside your computer](#).
2. Remove the:
 - a. [battery](#)
 - b. [optical drive](#)
 - c. [keyboard](#)
 - d. [base cover](#)
3. To remove the heat sink assembly:
 - a. Disconnect the system fan cable from the system board [1].
 - b. Loosen the captive screws that secure the heat sink assembly to the system board [2].
 - c. Remove the heat sink assembly from the system board [3].

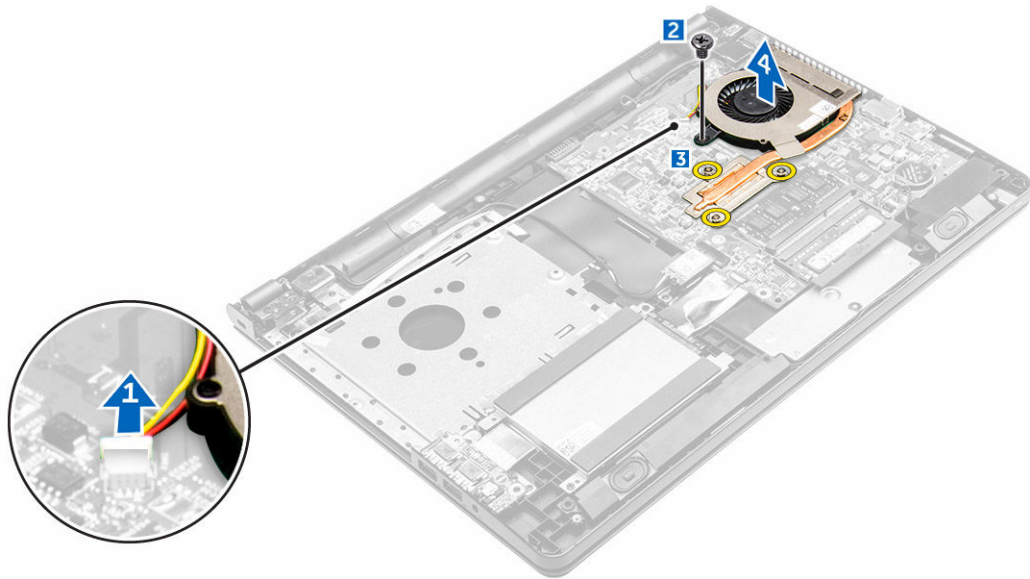

Installing the heat sink assembly

1. Align the screws on the heat sink with the screw holders on the system board.
2. Install the heat sink assembly and tighten the captive screws to secure it to the system board.
3. Connect the system fan cable to the system board.
4. Install the:
 - a. [base cover](#)
 - b. [keyboard](#)
 - c. [optical drive](#)
 - d. [battery](#)
5. Follow the procedures in [After working inside your computer](#).

Removing the system board

1. Follow the procedure in [Before working inside your computer](#).
2. Remove the:
 - a. [battery](#)
 - b. [optical drive](#)
 - c. [keyboard](#)
 - d. [base cover](#)
 - e. [hard drive assembly](#)
 - f. [WLAN card](#)
 - g. [I/O board](#)
 - h. [memory module](#)
 - i. [coin cell battery](#)
 - j. [heat sink](#)
3. Lift the locking tab to disconnect the optical drive and power button cable [1, 2].



4. Turn the computer over and unrout the WLAN cable [1].
5. Remove the screw and lift the hinge that secures the system board to the computer [2,3].

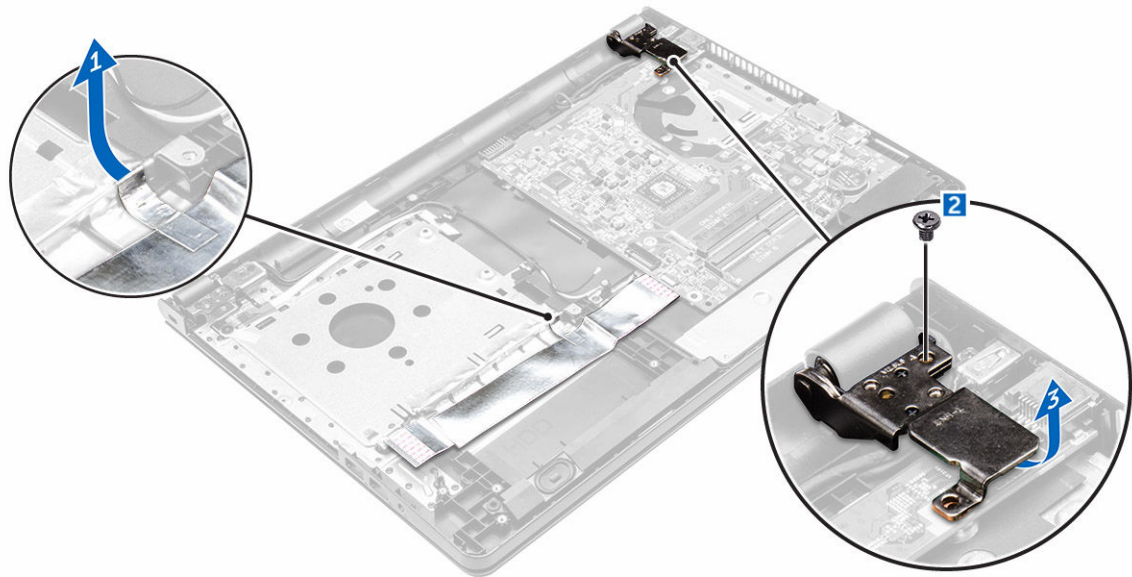

6. Remove the screw that secures the system board to the computer [1] and lift the system board [2].

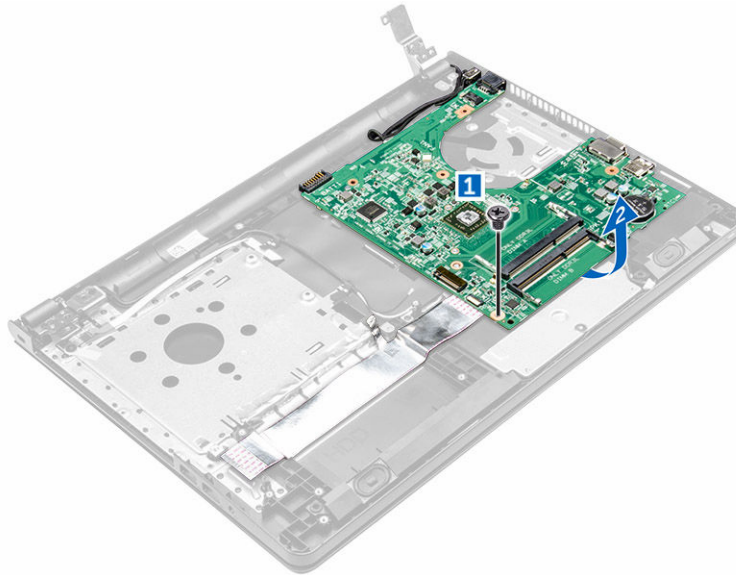

7. Turn the system board over.
8. To remove the system board:
 - a. Remove the white adhesive tape [1].
 - b. Unlock the tab and disconnect the eDP cable [2, 3].
 - c. Disconnect the power cable [4].
 - d. Remove the system board from the computer.



Installing the system board

1. Connect power cable and eDP cable.
2. Replace the white adhesive tape.
3. Turn the system board over.

4. Align the system board with the screw holders on the computer.
5. Tighten the screws to secure the system board to the computer.
6. Close the hinge and tighten the screws to secure the system board to the computer.
7. Turn the computer over and open the computer and connect the optical drive cable and the touch pad cable to the system board.
8. Install the:
 - a. [WLAN card](#)
 - b. [I/O board connector](#)
 - c. [memory module](#)
 - d. [heat sink](#)
 - e. [coin cell battery](#)
 - f. [base cover](#)
 - g. [optical drive](#)
 - h. [keyboard](#)
 - i. [battery](#)
9. Follow the procedure in [After working inside your computer](#).

Removing the power connector

1. Follow the procedure in [Before working inside your computer](#).
2. Remove the:
 - a. [battery](#)
 - b. [optical drive](#)
 - c. [keyboard](#)
 - d. [base cover](#)
 - e. [hard drive assembly](#)
 - f. [optical drive](#)
 - g. [WLAN card](#)
 - h. [i/o board](#)
 - i. [memory module](#)
 - j. [coin cell battery](#)
 - k. [heat sink](#)
 - l. [system board](#)
3. To remove the power connector:
 - a. Remove the black adhesive tape and unrout the power cable [1].
 - b. Remove the screw that secures the power connector to the computer [2].
 - c. Lift the power connector.

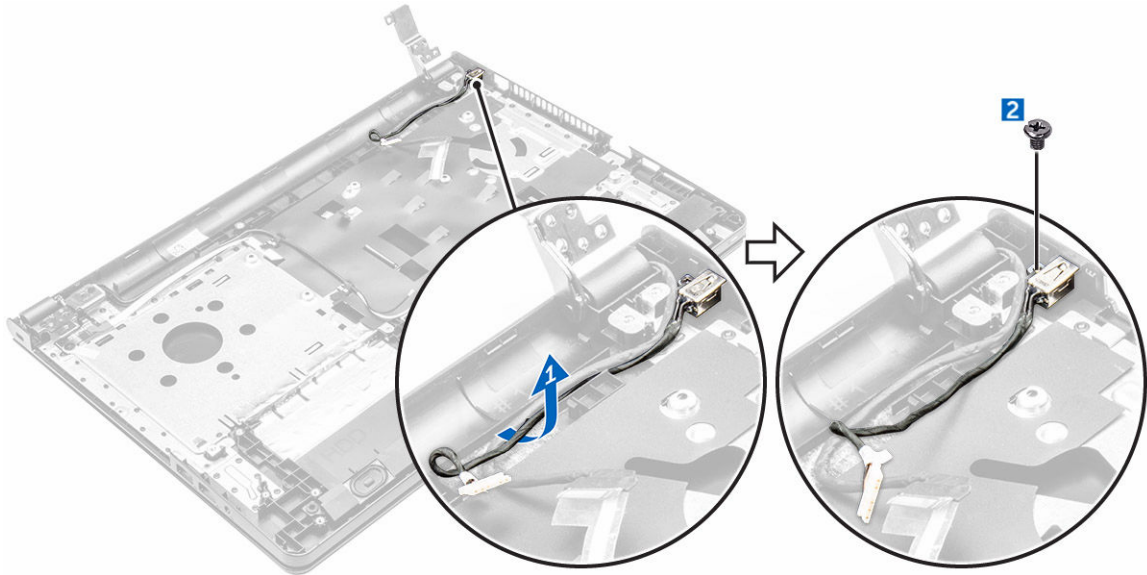

Installing the power connector

1. Insert the power connector into the slot on the computer.
2. Route the power connector cable through the routing channel.
3. Secure the power connector to the computer by using the screw.
4. Install the:
 - a. [system board](#)
 - b. [WLAN card](#)
 - c. [I/O board](#)
 - d. [memory module](#)
 - e. [heat sink](#)
 - f. [coin cell battery](#)
 - g. [base cover](#)
 - h. [optical drive](#)
 - i. [battery](#)
 - j. [keyboard](#)
5. Follow the procedure in [After working inside your computer](#).

Removing the display assembly

1. Follow the procedure in [Before working inside your computer](#).
2. Remove the:
 - a. [battery](#)
 - b. [optical drive](#)
 - c. [keyboard](#)
 - d. [base cover](#)
 - e. [hard drive assembly](#)
 - f. [optical drive](#)
 - g. [WLAN card](#)

- h. [i/o board](#)
- i. [memory module](#)
- j. [coin cell battery](#)
- k. [heat sink](#)
- l. [system board](#)
- m. [power connector](#)

3. Unroute the WLAN and eDP cable [1, 2, 3].

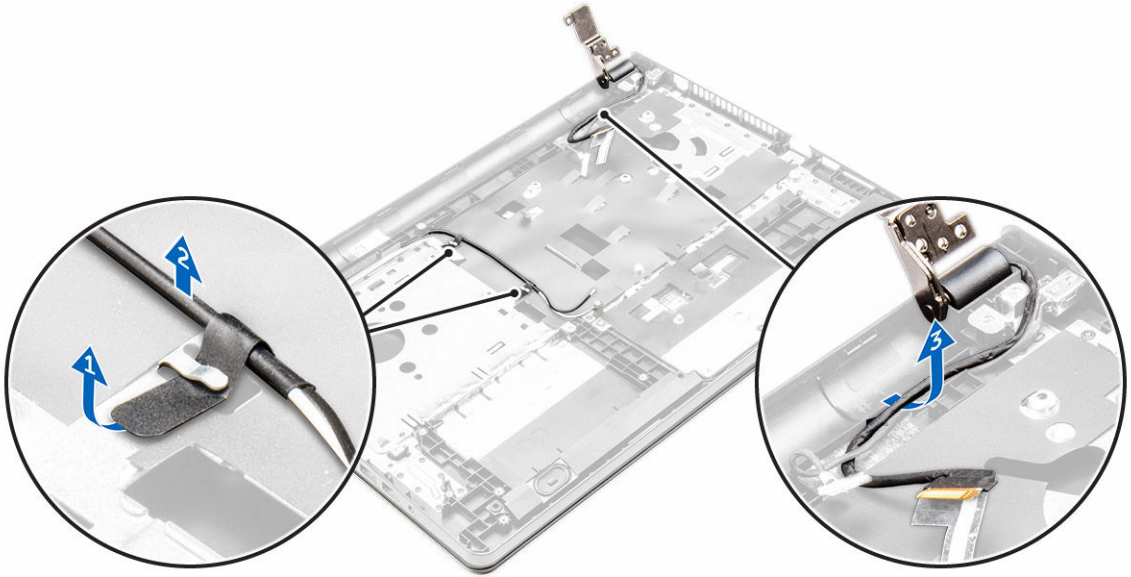

4. To remove the display assembly:

- a. Remove and lift the screws that secure the display hinge to the computer [1, 2].
- b. Lift and remove the display assembly [3,4].

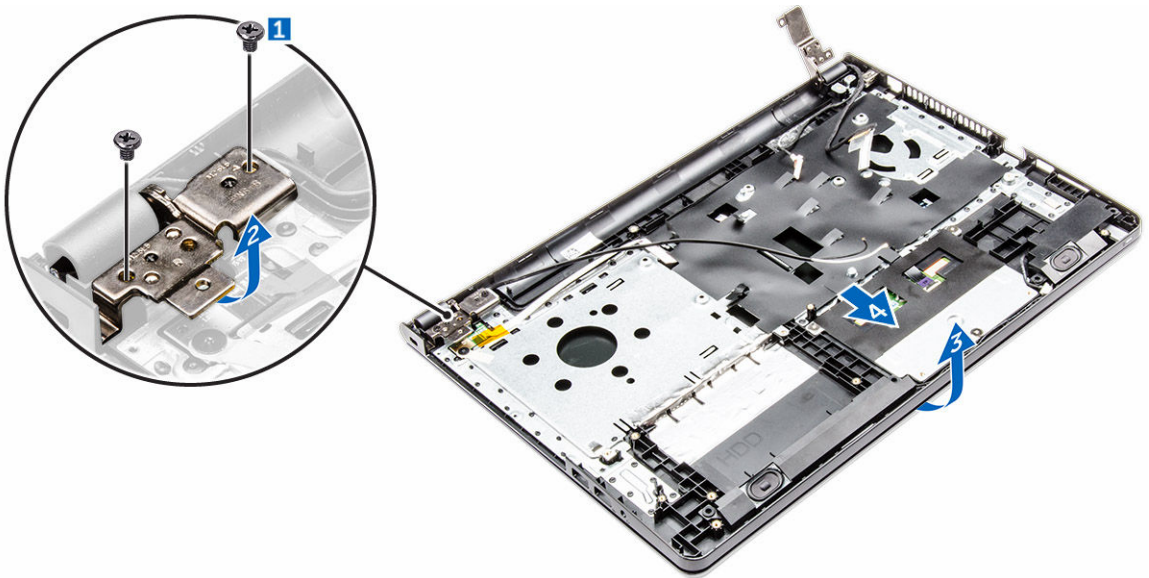

Installing the display assembly

1. Align the display assembly with the chassis.
2. Route the WLAN and display assembly cables through the cable securing tabs.
3. Tighten the display hinges screws to secure the display assembly.
4. Install the:
 - a. [coin cell battery](#)
 - b. [system board](#)
 - c. [power connector](#)
 - d. [keyboard](#)
 - e. [WLAN card](#)
 - f. [I/O board](#)
 - g. [memory module](#)
 - h. [heat sink](#)
 - i. [base cover](#)
 - j. [optical drive](#)
 - k. [battery](#)
5. Follow the procedure in [After working inside your computer](#).

Removing the display bezel

1. Follow the procedure in [Before working inside your computer](#).
2. Remove the:
 - a. [battery](#)
 - b. [optical drive](#)
 - c. [keyboard](#)
 - d. [base cover](#)
 - e. [hard drive assembly](#)
 - f. [optical drive](#)
 - g. [WLAN card](#)
 - h. [I/O board](#)
 - i. [memory module](#)
 - j. [coin cell battery](#)
 - k. [heat sink](#)
 - l. [system board](#)
 - m. [power connector](#)
 - n. [display assembly](#)
3. To disconnect the display bezel:
 - a. By using a plastic scribe, release the tabs on the edges to release the display bezel from the display assembly [1].
 - b. Remove the display bezel display assembly [2].

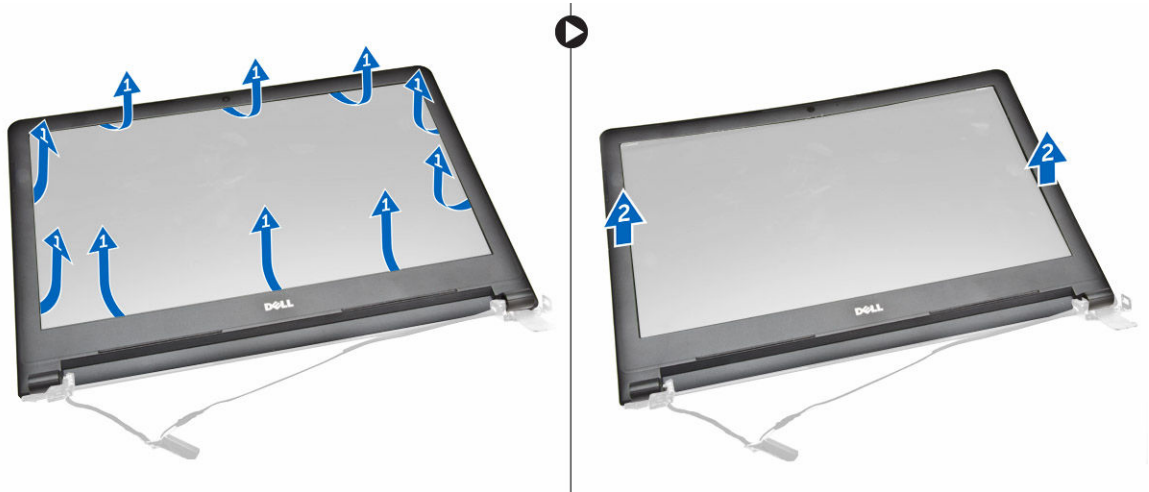

Installing the display bezel

1. Place the display bezel on the display assembly.
2. Press the display bezel until it clicks onto the display assembly.
3. Install the:
 - a. [display assembly](#)
 - b. [keyboard](#)
 - c. [WLAN card](#)
 - d. [I/O board](#)
 - e. [memory module](#)
 - f. [heat sink](#)
 - g. [base cover](#)
 - h. [coin cell battery](#)
 - i. [system board](#)
 - j. [power connector](#)
 - k. [battery](#)
 - l. [optical drive](#)
4. Follow the procedure in [After working inside your computer](#).

Removing the camera

1. Follow the procedure in [Before working inside your computer](#).
2. Remove the:
 - a. [battery](#)
 - b. [optical drive](#)
 - c. [keyboard](#)
 - d. [base cover](#)
 - e. [hard drive assembly](#)
 - f. [optical drive](#)
 - g. [WLAN card](#)
 - h. [I/O board](#)

- i. [memory module](#)
 - j. [coin cell battery](#)
 - k. [heat sink](#)
 - l. [system board](#)
 - m. [power connector](#)
 - n. [display assembly](#)
 - o. [display bezel](#)
3. To remove the camera:
- a. Remove the tape that secures the camera cable [1].
 - b. Disconnect the camera cable from the camera [2].
 - c. Remove the camera from the display assembly [3].

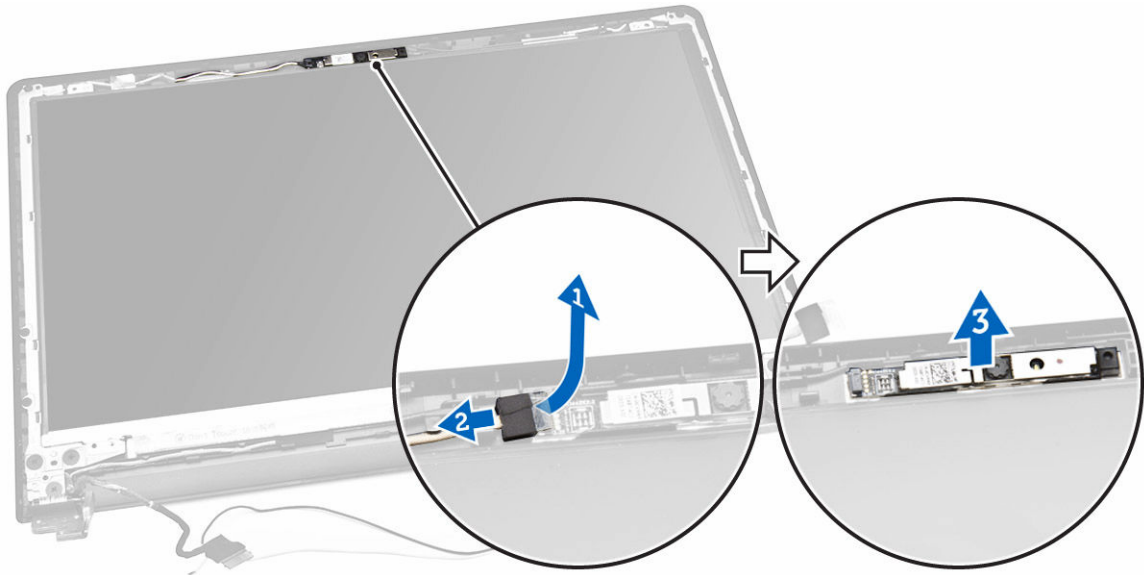

Installing the camera

- 1. Install the camera into the slot on the display assembly.
- 2. Connect the camera cable.
- 3. Install the:
 - a. [display assembly](#)
 - b. [display bezel](#)
 - c. [keyboard](#)
 - d. [WLAN card](#)
 - e. [I/O board](#)
 - f. [memory module](#)
 - g. [heat sink](#)
 - h. [base cover](#)
 - i. [coin cell battery](#)
 - j. [system board](#)
 - k. [power connector](#)
 - l. [battery](#)
 - m. [optical drive](#)

4. Follow the procedure in [After working inside your computer.](#)

Removing the display panel

1. Follow the procedure in [Before working inside your computer.](#)
2. Remove the:
 - a. [battery](#)
 - b. [optical drive](#)
 - c. [keyboard](#)
 - d. [base cover](#)
 - e. [hard drive assembly](#)
 - f. [optical drive](#)
 - g. [WLAN card](#)
 - h. [I/O board](#)
 - i. [memory module](#)
 - j. [coin cell battery](#)
 - k. [heat sink](#)
 - l. [system board](#)
 - m. [power connector](#)
 - n. [display assembly](#)
 - o. [display bezel](#)
 - p. [camera](#)
3. To remove the display panel:
 - a. Remove the screws that secure the display panel to the display assembly [1].
 - b. Lift the display panel to access the cables underneath [2].

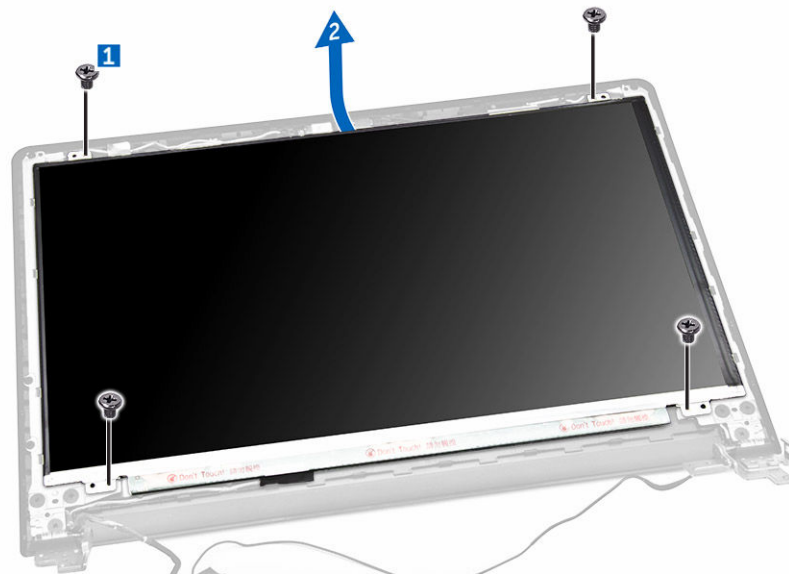

4. To disconnect the cable:
 - a. Remove the tape that secures the eDP cable to the display panel [1].
 - b. Lift the locking tab and remove the eDP cable [2, 3].
 - c. Remove the display panel from the computer [4].

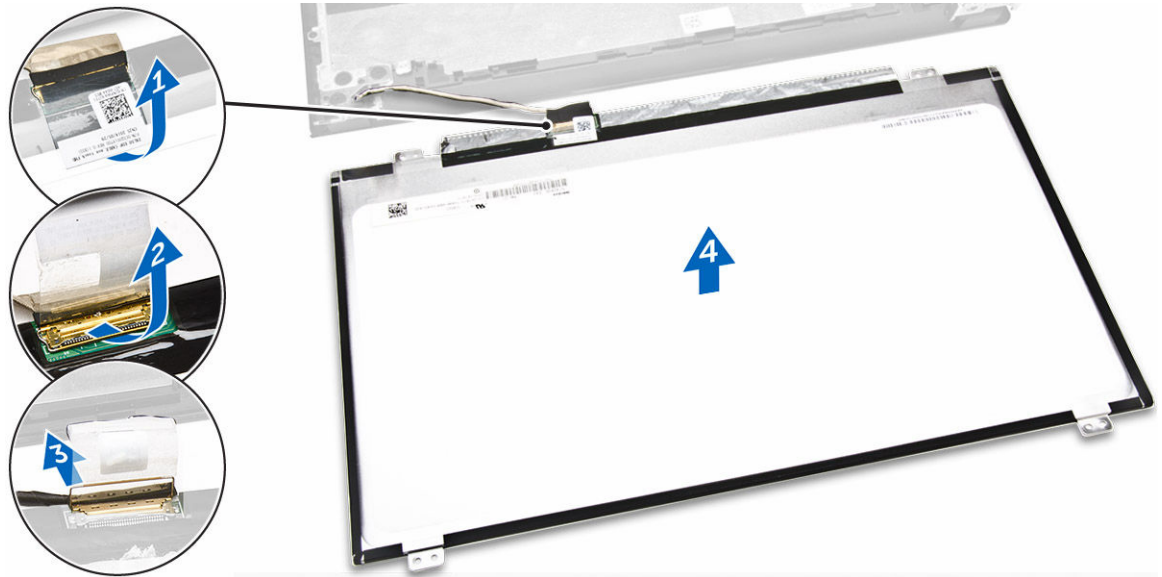

Installing the display panel

1. Connect the eDP cable to the display panel.
2. Affix the tape to secure the display cable.
3. Place the display panel on the display assembly.
4. Tighten the screws to secure the display panel to the display assembly.
5. Install the:
 - a. [display assembly](#)
 - b. [display bezel](#)
 - c. [camera](#)
 - d. [keyboard](#)
 - e. [WLAN card](#)
 - f. [i/o board](#)
 - g. [memory module](#)
 - h. [heat sink](#)
 - i. [base cover](#)
 - j. [coin cell battery](#)
 - k. [system board](#)
 - l. [power connector](#)
 - m. [battery](#)
 - n. [optical drive](#)
6. Follow the procedure in [After working inside your computer](#).

Removing the display hinges

1. Follow the procedure in [Before working inside your computer](#).
2. Remove the:
 - a. [battery](#)
 - b. [optical drive](#)

- c. [keyboard](#)
 - d. [base cover](#)
 - e. [hard drive assembly](#)
 - f. [optical drive](#)
 - g. [WLAN card](#)
 - h. [I/O board](#)
 - i. [memory module](#)
 - j. [coin cell battery](#)
 - k. [heat sink](#)
 - l. [system board](#)
 - m. [power connector](#)
 - n. [display assembly](#)
 - o. [display bezel](#)
 - p. [camera](#)
 - q. [display panel](#)
3. To remove the hinges:
- a. Remove the screws that secure the display hinges to the display assembly [1].
 - b. Remove the display hinges [2].

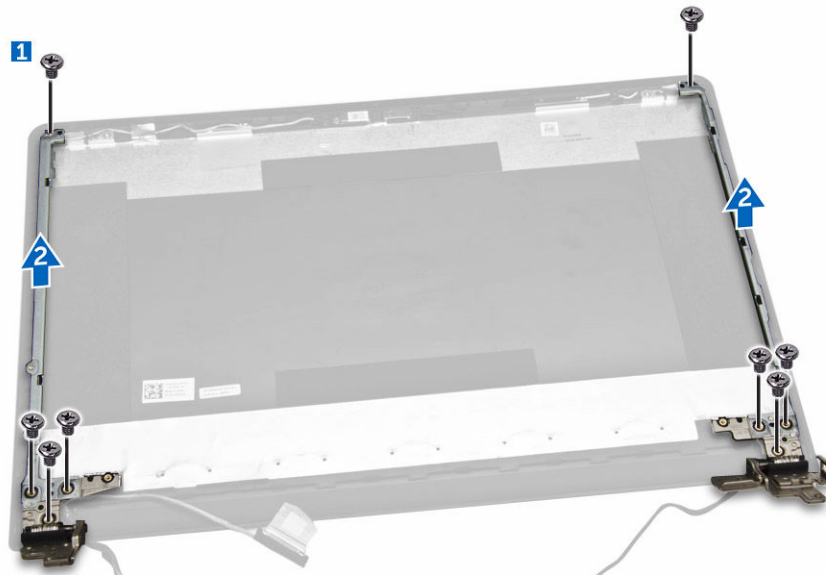

Installing the display hinges

- 1. Tighten the screws to secure the display hinges to the display assembly.
- 2. Install the:
 - a. [display assembly](#)
 - b. [display bezel](#)
 - c. [display panel](#)
 - d. [camera](#)
 - e. [system board](#)
 - f. [power connector](#)
 - g. [WLAN card](#)

- h. [I/O board](#)
 - i. [memory module](#)
 - j. [heat sink](#)
 - k. [coin cell battery](#)
 - l. [optical drive](#)
 - m. [base cover](#)
 - n. [keyboard](#)
 - o. [battery](#)
3. Follow the procedure in [After working inside your computer.](#)

Technology and components

Power adapter

This laptop is shipped with the 45 W power adapter. This adapter uses a USB Type C connector.

 **WARNING:** When you disconnect the power adapter cable from the laptop, grasp the connector, not the cable itself, and then pull firmly but gently to avoid damaging the cable.

 **WARNING:** The power adapter works with electrical outlets worldwide. However, power connectors and power strips vary among countries. Using an incompatible cable or improperly connecting the cable to the power strip or electrical outlet may cause fire or damage the equipment.

Processors

This laptop is shipped with the AMD A6–7310 processor.

 **NOTE:** The clock speed and performance varies depending on the workload and other variables.

Identifying processors in Windows 10

1. Click **Search the Web and Windows**.
2. Type `Device Manager`.
3. Select **Processor**.

The basic information of the processor is displayed

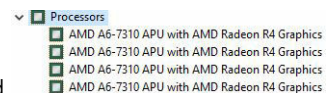

Identifying processors in Windows 7

1. Click **Start**.
2. Type `Device Manager`.
3. Select **Processor**.

The basic information of the processor is displayed.

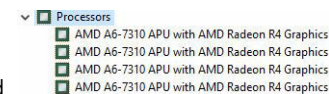

Verifying the processor usage in Task Manager

1. Right click on the taskbar.
2. Select **Start Task Manager**.
The **Windows Task Manager** window is displayed.

- Click the **Performance** tab in the **Windows Task Manager** window.
The processor performance details are displayed.

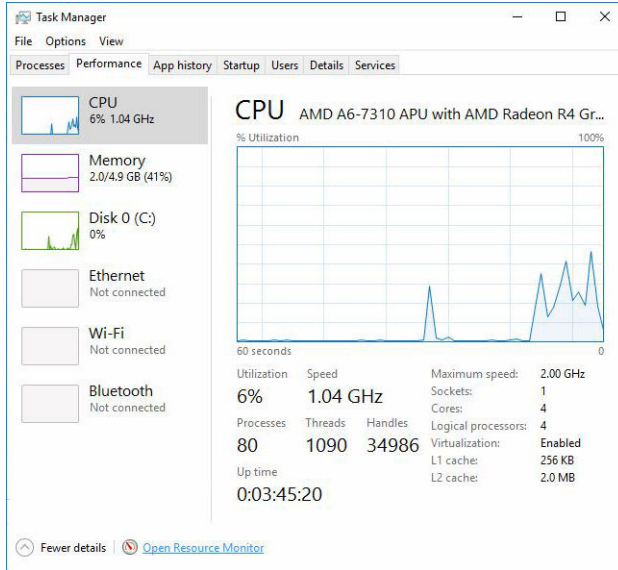

Verifying the processor usage in Resource Monitor

- Right click on the taskbar.
- Select **Start Task Manager**.
The **Windows Task Manager** window is displayed.
- Click the **Performance** tab in the **Windows Task Manager** window.
The processor performance details are displayed.
- Click **Open Resource Monitor**.

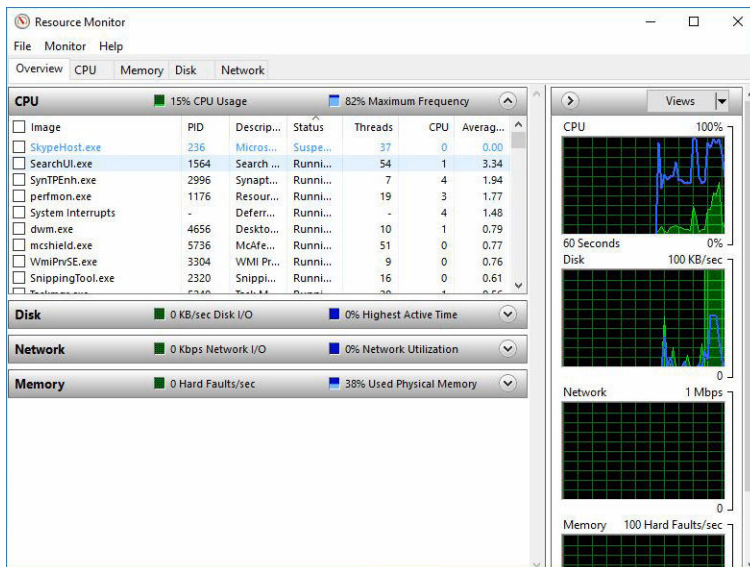

Chipsets

All laptop communicate with the CPU through the chipset.

Downloading the chipset driver

1. Turn on the laptop.
2. Go to www.Dell.com/support.
3. Click **Product Support**, enter the Service Tag of your laptop, and then click **Submit**.

 **NOTE:** If you do not have the Service Tag, use the autodetect feature or manually browse for your laptop model.

4. Click **Drivers and Downloads**.
5. Select the operating system installed on your laptop.
6. Scroll down the page, expand **Chipset**, and select your chipset driver.
7. Click **Download File** to download the latest version of the chipset driver for your laptop.
8. After the download is complete, navigate to the folder where you saved the driver file.
9. Double-click the chipset driver file icon and follow the instructions on the screen.

Identifying the chipset in Device Manager on Windows 10

1. Click **All Settings**  on the Windows 10 **Charms Bar**.
2. From the **Control Panel**, select **Device Manager**.
3. Expand **System Devices** and search for the chipset.

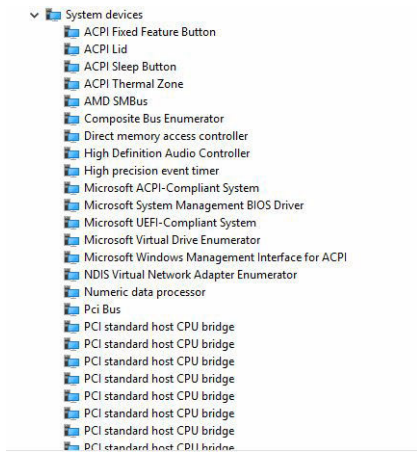

Identifying chipset in Device Manager on Windows 7

1. Click **Start** → **Control Panel** → **Device Manager**.
2. Expand **System Devices** and search for the chipset.

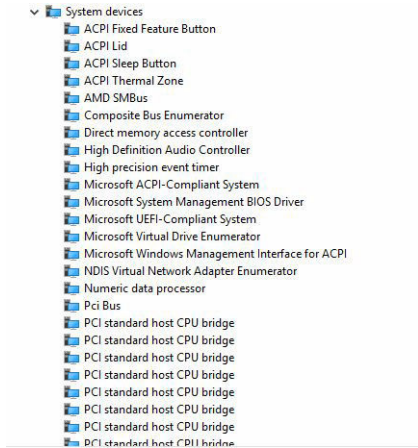

Graphic chipset

This laptop is shipped with the AMD Radeon R4 graphics chipset.

AMD chipset drivers

Verify if the AMD chipset drivers are already installed in the laptop.

Table 1. AMD chipset drivers

Before installation	After installation

AMD Radeon Graphics drivers

Verify if the AMD Radeon Graphics drivers are already installed in the laptop.

Table 2. AMD Radeon Graphics drivers

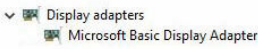
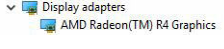
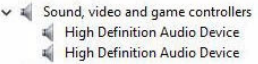
Before installation	After installation
	
	

Display options

This laptop supports a 15 inch HD with 1366 x 768 resolution (maximum).

Identifying the display adapter

1. Click or tap **Start** and select **Settings**.
2. Type `Device Manager` in the search box and tap **Device Manager** from the left pane.
3. Expand **Display adapters**.

The display adapters are displayed.



Changing the screen resolution

1. Right-click or tap and select **Display Settings**.
2. Tap or click **Advanced display settings**.
3. Select the required resolution from the drop-down list and tap or click **Apply**.

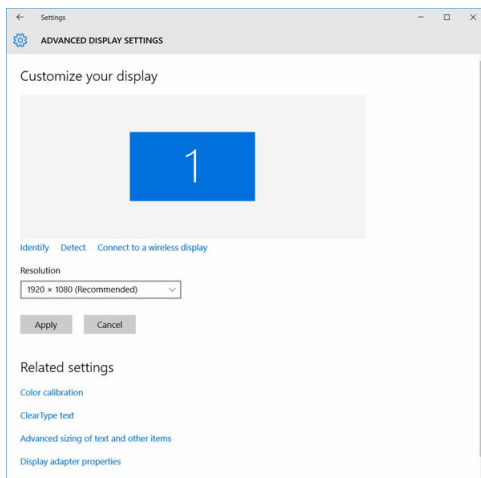

Rotating the display

1. Right click on the desktop screen.
A sub menu is displayed.
2. Select **Graphic Options** → **Rotation** and choose one of the following:
 - Rotate to Normal
 - Rotate to 90 Degrees
 - Rotate to 180 Degrees
 - Rotate to 270 Degrees

 **NOTE:** The display can also be rotated using the following key combinations:

- Ctrl + Alt + Up arrow key (Rotate to normal)
- Right arrow key (Rotate 90 degrees)
- Down arrow key (Rotate 180 degrees)
- Left arrow key (Rotate 270 degrees)

Adjusting brightness in Windows 10

To enable or disable automatic screen brightness adjustment:

1. Click or tap **All Settings**  → **System** → **Display**.
2. Use the **Adjust my screen brightness automatically** slider to enable or disable automatic-brightness adjustment.

 **NOTE:** You can also use the **Brightness level** slider to adjust the brightness manually.

Adjusting brightness in Windows 7

To enable or disable automatic screen brightness adjustment:

1. Click **Start** → **Control Panel** → **Display**.
2. Use the **Adjust brightness** slider to enable or disable automatic-brightness adjustment.

 **NOTE:** You can also use the **Brightness level** slider to adjust the brightness manually.

Cleaning the display

1. Check for any smudges or areas that have to be cleaned.
2. Use a microfiber cloth to remove any obvious dust and gently brush off any dirt particles.
3. Proper cleaning kits should be used to clean and keep your display in a crisp clear pristine condition.

 **NOTE:** Never spray any cleaning solutions directly on the screen; spray it to the cleaning cloth.

4. Gently wipe the screen in a circular motion. Do not press hard on the cloth.

 **NOTE:** Do not press hard or touch the screen with your fingers or you may leave oily prints and smears.

 **NOTE:** Do not leave any liquid on the screen.

5. Remove all excess moisture as it may damage your screen.

6. Let the display dry thoroughly before you turn it on.
7. For stains that are hard to remove, repeat this procedure till the display is clean.

Connecting to external display devices

1. Ensure that the projector is turned on and plug the projector cable into a video port on your laptop.
2. Press the Windows logo + P key.
3. Select one of the following modes:
 - **PC screen only**
 - **Duplicate**
 - **Extend**
 - **Second Screen only**

 **NOTE:** For more information, see the document that shipped with your display device.

Audio options

Downloading the audio driver

1. Turn on the laptop.
2. Go to www.Dell.com/support.
3. Click **Product Support**, enter the Service Tag of your laptop and click **Submit**.
 -  **NOTE:** If you do not have the Service Tag, use the autodetect feature or manually browse for your laptop model.
4. Click **Drivers and Downloads**.
5. Select the operating system installed on your laptop.
6. Scroll down the page and expand **Audio**.
7. Select the audio driver.
8. Click **Download File** to download the latest version of the audio driver for your laptop.
9. After the download is complete, navigate to the folder where you saved the audio driver file.
10. Double-click the audio driver file icon and follow the instructions on the screen.

Realtek ALC3234–CG Waves MaxxAudio Pro controller

This laptop ships with integrated Realtek ALC3234–CG Waves MaxxAudio Pro controller. It is a High Definition audio codec designed for Windows desktop and laptops.

Downloading the audio driver

1. Turn on the laptop.
2. Go to www.Dell.com/support.
3. Click **Product Support**, enter the Service Tag of your laptop and click **Submit**.
 -  **NOTE:** If you do not have the Service Tag, use the autodetect feature or manually browse for your laptop model.
4. Click **Drivers and Downloads**.
5. Select the operating system installed on your laptop.

6. Scroll down the page and expand **Audio**.
7. Select the audio driver.
8. Click **Download File** to download the latest version of the audio driver for your laptop.
9. After the download is complete, navigate to the folder where you saved the audio driver file.
10. Double-click the audio driver file icon and follow the instructions on the screen.

Identifying the audio controller in Windows 10

1. Click **All Settings**  on the Windows 10 **Charms bar**.
2. Type `Device Manager` in the search box and select **Device Manager** from the left pane.
3. Expand **Sound, video and game controllers**.

The audio controller is displayed.

Table 3. Identifying the audio controller in Windows 10

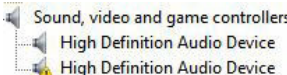
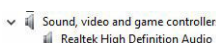

Before installation	After installation
	

Identifying the audio controller in Windows 7

1. Type `Device Manager` in the search box and select **Device Manager** from the left pane.
2. Expand **Sound, video and game controllers**.

The audio controller is displayed.

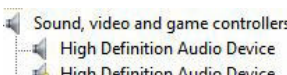
Table 4. Identifying the audio controller in Windows 7

Before installation	After installation
	

Realtek HD audio drivers

Verify if the Realtek audio drivers are already installed in the laptop.

Table 5. Realtek HD audio drivers

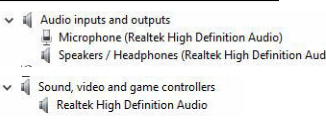
Before installation	After installation
	

WLAN card

This laptop supports a WLAN card.

Hard drive options

This laptop supports 1 TB hard drive.

Identifying the hard drive in Windows 10

1. Click **All Settings**  on the Windows 10 **Charms bar**.
2. Click **Control Panel**, select **Device Manager**, and expand **Disk drives**.

The hard drive is listed under **Disk drives**. 

Identifying the hard drive in Windows 7

Click **Control Panel**, select **Device Manager**, and expand **Disk drives**.

The hard drive is listed under Disk drives. 

Entering BIOS setup

1. Turn on or restart your laptop.
2. After the Dell logo is displayed, tap F2 until the **Entering BIOS setup** message appears. To enter the Boot selection menu, tap F12
Hard drive is listed under the **Setup Utility Options** under the **Main** group.

Camera features

This laptop is shipped with front-facing camera with the image resolution of 1280 x 720 (maximum).

Identifying the camera in Device Manager on Windows 10

1. In the **Search** box, type `device manager`, and click `imaging devices` to start it.
2. Under **Device Manager**, expand **Imaging devices**.

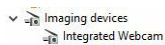

Identifying the camera in Device Manager on Windows 7

1. Select **Control Panel**.
2. Select **Device Manager** and expand **Imaging devices**.

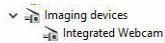

Starting the camera

To start the camera, open an application that uses the camera. For instance, if you tap the Dell webcam central software or the Skype software that is shipped with the laptop, the camera turns on. Similarly, if you are chatting on the internet and the application requests to access the webcam, the webcam turns on.

Starting the Camera App

1. Click the **Windows** button and select **All apps**.

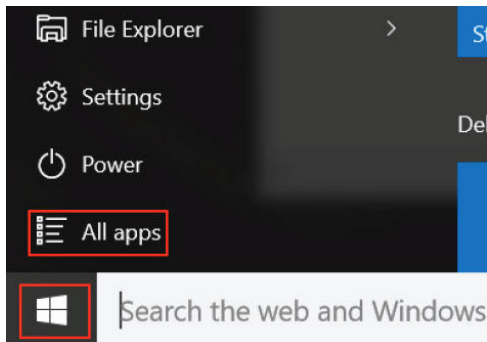

2. Select **Camera** from the apps list.

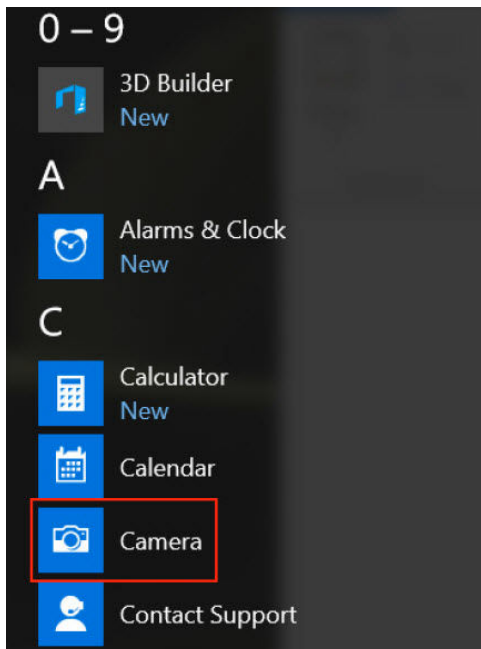

3. If the **Camera** App is not available in the apps list, search for it.

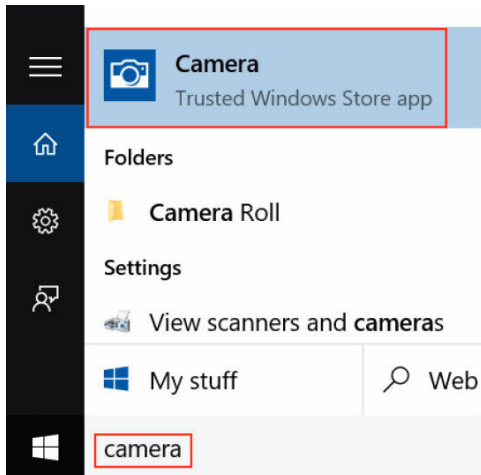

Memory features

In this laptop, the memory (RAM) is a part of the system board. This laptop supports DDR3L SO-DIMM with 2 slots, up to 1600 MHz.

Verifying system memory in Windows 10

1. Click or tap **Windows** → **All Settings**  → **System**.
2. Under **System**, select **About**.

Verifying system memory in Windows 7

1. From your desktop, start the **Charms** bar.
2. Select **Control Panel** and then select **System**.

Verifying system memory in setup

1. Turn on or restart your laptop.
2. After the Dell logo is displayed, tap F2 until the **Entering BIOS setup** message appears. To enter the Boot selection menu, tap F12
3. On the left pane, select **Settings** → **General** → **System Information**.
The memory information is displayed on the right pane.

Testing memory using ePSA

1. Turn on or restart your laptop.
2. Perform one of the following actions after the Dell logo is displayed:
 - With keyboard — Press F2.
 - Without keyboard — Press and hold the **Volume Up** button when the Dell logo is displayed on the screen. When the F12 boot selection menu is displayed, select **Diagnostics** from the boot menu, and press Enter.

The PreBoot System Assessment (PSA) starts on your laptop.

 **NOTE:** If you wait too long and the operating system logo appears, wait until you see the desktop. Turn off the laptop and try again.

System Setup

System Setup enables you to manage your computer hardware and specify BIOS level options. From the System Setup, you can:

- Change the NVRAM settings after you add or remove hardware
- View the system hardware configuration
- Enable or disable integrated devices
- Set performance and power management thresholds
- Manage your computer security

Boot Sequence

Boot Sequence allows you to bypass the System Setup-defined boot device order and boot directly to a specific device (for example: optical drive or hard drive). During the Power-on Self Test (POST), when the Dell logo appears, you can:

- Access System Setup by pressing F2 key
- Bring up the one-time boot menu by pressing F12 key

The one-time boot menu displays the devices that you can boot from including the diagnostic option. The boot menu options are:

- Removable Drive (if available)
- STXXXX Drive

 **NOTE:** XXX denotes the SATA drive number.

- Optical Drive
- Diagnostics

 **NOTE:** Choosing **Diagnostics**, will display the **ePSA diagnostics** screen.

The boot sequence screen also displays the option to access the System Setup screen.

Navigation keys

The following table displays the system setup navigation keys.

 **NOTE:** For most of the System Setup options, changes that you make are recorded but do not take effect until you restart the system.

Navigation keys

The following tables describes the function of Navigation keys

Keys	Navigation
Up arrow	Moves to the previous field.
Down arrow	Moves to the next field.
Enter	Allows you to select a value in the selected field (if applicable) or follow the link in the field.
Spacebar	Expands or collapses a drop-down list, if applicable.
Tab	Moves to the next focus area.
	 NOTE: For the standard graphics browser only.
Esc	Moves to the previous page till you view the main screen. Pressing Esc in the main screen displays a message that prompts you to save any unsaved changes and restarts the system.
F1	Displays the System Setup help file.

Setup Utility options

Main screen option

The Main tab lists out the primary hardware features of the computer.

Option	Description				
System Time	Resets the time on the computer's internal clock.				
System Date	Resets the date on the computer's internal calendar.				
BIOS Version	Displays the BIOS revision.				
Product Name	Displays the computer model number.				
Service Tag	Displays the Service Tag of your computer.				
Asset Tag	Displays the asset tag of your computer.				
CPU Type	Displays the processor model number.				
CPU Speed	Displays the processor speed.				
CPU ID	Displays the processor ID.				
CPU Cache	<table> <tbody> <tr> <td>L1 Cache</td> <td>Displays the processor L1 cache size.</td> </tr> <tr> <td>L2 Cache</td> <td>Displays the processor L2 cache size.</td> </tr> </tbody> </table>	L1 Cache	Displays the processor L1 cache size.	L2 Cache	Displays the processor L2 cache size.
L1 Cache	Displays the processor L1 cache size.				
L2 Cache	Displays the processor L2 cache size.				
Fixed HDD	Displays the hard drive ID and capacity.				
SATA ODD	Displays the type of ODD.				
AC Adapter Type	Displays the power adapter type.				
System Memory	Displays the memory capacity and type.				

Option	Description
Extended Memory	Displays the extended memory capacity.
Memory Speed	Displays the memory speed.

Advanced screen option

The **Advanced** tab allows you to set various functions that affect the performance of the computer. The table below defines the function of each option and its default value.

Option	Description	
Power Now	You can enable or disable the Power Now-Enable. Default: Enabled	
Virtualization	You can enable or disable the Virtualization. Default: Enabled	
Integrated NIC	You can enable or disable the Integrated NIC. Default: Enabled	
USB Emulation	You can enable or disable the USB Emulation. Default: Enabled	
USB Wake Support	You can enable or disable the USB Wake Support. Default: Disabled	
SATA Operation	You can choose the SATA operation mode. Default: AHCI	
Adapter Warnings	You can enable or disable the Adapter Warnings. Default: Enabled	
Function Key Behavior	You can enable or disable the Function Key Behavior. Default: Multimedia Keys	
Battery Health	You can battery performance.	
Miscellaneous Devices	External USB Ports	You can enable or disable the External USB Ports. Default: Enabled
	Microphone	You can enable or disable the Microphone. Default: Enabled
	Camera	You can enable or disable the Camera mode. Default: Enabled
	Internal Bluetooth	You can enable or disable the Internal Bluetooth. Default: Enabled
	Internal WLAN	You can enable or disable the Internal WLAN. Default: Enabled
	Media Card Reader	You can enable or disable the Media Card Reader. Default: Enabled
	Optical Device	You can enable or disable the Optical Device. Default: Enabled
	Boot Disable	You can enable or disable the Boot Disable. Default: Disabled
	USB debug	You can enable or disable the USB debug. Default: Disabled

Option	Description
Battery Charge Configuration	You can enable or disable the Battery Charge Configuration. Default: Adaptive
Advanced Battery Charge Mode	You can enable or disable the Advanced Battery Charge Mode. Default: Disabled

Security screen option

The **Security** tab displays the security status and allows you to manage the security features of the computer.

Option	Description
Unlock Setup Status	You can enable an Unlock Setup Status (Default: Unlocked).
Admin Password Status	You can set, change or delete the administrator (admin) password status.
System Password Status	You can set, change or delete the system password status.
HDD Passwords Status	You can set, change or delete the password on the system hard-disk drive.
Set Admin Password	You can set, change or delete the administrator (admin) password.
Set System Password	You can set, change or delete the system password.
Set HDD Passwords	You can set, change or delete the password on the system hard-disk drive.
Password Change	You can enable the disable permission to the System and Hard Drive passwords when the admin password is set.
Firmware TPM	You can set, change or delete the password on the Firmware TPM.
Password Bypass	You can enable or disable the permission to bypass the System when they are set.
Computrace	You can activate or disable the optional Computrace software (Default: Deactivated).

Boot

The **Boot** tab allows you to change the boot sequence.

Option	Description
Boot List Option	Allows you to change the order in which the computer attempts to find an operating system. Default: UEFI
File Browser Add Boot Option	Allows you to Add file browser boot option.

Option	Description
File Browser Delete Boot Option	Allows you to Delete file browser boot option.
Secure Boot	Enable or disable the Secure Boot Control. Default: Enabled
Load Legacy Option ROM	This option control whether CSM should be loaded during POST. Default: Disabled
Boot Option Priorities	Boot Option 1 Allows you to select the 1st boot device preference.
	Boot Option 2 Allows you to select the 2nd boot device preference.
	Boot Option 3 Allows you to select the 3rd boot device preference.

Exit

This section allows you to save, discard and load default settings before exiting from Setup Utility.

Option	Description
Save Changes and Reset	Allows you to Save Changes and Reset default setting before exiting from Setup Utility.
Discard Changes and Reset	Allows you to Discard Changes and Reset default setting before exiting from Setup Utility.
Restore Defaults	Allows you to Restore Default setting before exiting from Setup Utility.
Discard Changes	Allows you to Discard Changes setting before exiting from Setup Utility.
Save Changes	Allows you to Save Changes setting before exiting from Setup Utility.

Updating the BIOS

It is recommended to update your BIOS (System Setup), on replacing the system board or if an update is available. For laptops, ensure that your computer battery is fully charged and connected to a power outlet

1. Restart the computer.
2. Go to **Dell.com/support**.
3. Enter the **Service Tag** or **Express Service Code** and click **Submit**.



NOTE: To locate the Service Tag, click **Where is my Service Tag?**



NOTE: If you cannot find your Service Tag, click **Detect My Product**. Proceed with the instructions on screen.

4. If you are unable to locate or find the Service Tag, click the Product Category of your computer.
5. Choose the **Product Type** from the list.
6. Select your computer model and the **Product Support** page of your computer appears.
7. Click **Get drivers** and click **View All Drivers**.
The Drivers and Downloads page opens.

8. On the Drivers and Downloads screen, under the **Operating System** drop-down list, select **BIOS**.
9. Identify the latest BIOS file and click **Download File**.
You can also analyze which drivers need an update. To do this for your product, click **Analyze System for Updates** and follow the instructions on the screen.
10. Select your preferred download method in the **Please select your download method below** window, click **Download File**.
The **File Download** window appears.
11. Click **Save** to save the file on your computer.
12. Click **Run** to install the updated BIOS settings on your computer.
Follow the instructions on the screen.

 **NOTE:** It is recommended not to update the BIOS version for more than 3 revisions. For example: If you want to update the BIOS from 1.0 to 7.0, then install version 4.0 first and then install version 7.0.

System and setup password

You can create a system password and a setup password to secure your computer.

Password type	Description
System password	Password that you must enter to log on to your system.
Setup password	Password that you must enter to access and make changes to the BIOS settings of your computer.

 **CAUTION:** The password features provide a basic level of security for the data on your computer.

 **CAUTION:** Anyone can access the data stored on your computer if it is not locked and left unattended.

 **NOTE:** Your computer is shipped with the system and setup password feature disabled.

Assigning a system password and setup password

You can assign a new **System Password** and/or **Setup Password** or change an existing **System Password** and/or **Setup Password** only when **Password Status** is **Unlocked**. If the Password Status is **Locked**, you cannot change the System Password.

 **NOTE:** If the password jumper is disabled, the existing System Password and Setup Password are deleted and you need not provide the system password to log on to the computer.

To enter the system setup, press F2 immediately after a power-on or re-boot.

1. In the **System BIOS** or **System Setup** screen, select **System Security** and press Enter.
The **System Security** screen appears.
2. In the **System Security** screen, verify that **Password Status** is **Unlocked**.
3. Select **System Password**, enter your system password, and press Enter or Tab.
Use the following guidelines to assign the system password:
 - A password can have up to 32 characters.
 - The password can contain the numbers 0 through 9.
 - Only lower case letters are valid, upper case letters are not allowed.

- Only the following special characters are allowed: space, ("), (+), (,), (-), (.), (/), (:), (|), (\), (|), (').

Re-enter the system password when prompted.

4. Type the system password that you entered earlier and click **OK**.
5. Select **Setup Password**, type your system password and press Enter or Tab.
A message prompts you to re-type the setup password.
6. Type the setup password that you entered earlier and click **OK**.
7. Press Esc and a message prompts you to save the changes.
8. Press Y to save the changes.
The computer reboots.

Deleting or changing an existing system and/or setup password

Ensure that the **Password Status** is Unlocked (in the System Setup) before attempting to delete or change the existing System and/or Setup password. You cannot delete or change an existing System or Setup password, if the **Password Status** is Locked.

To enter the System Setup, press F2 immediately after a power-on or reboot.

1. In the **System BIOS** or **System Setup** screen, select **System Security** and press Enter.
The **System Security** screen is displayed.
2. In the **System Security** screen, verify that **Password Status** is **Unlocked**.
3. Select **System Password**, alter or delete the existing system password and press Enter or Tab.
4. Select **Setup Password**, alter or delete the existing setup password and press Enter or Tab.



NOTE: If you change the System and/or Setup password, re-enter the new password when prompted. If you delete the System and/or Setup password, confirm the deletion when prompted.

5. Press Esc and a message prompts you to save the changes.
6. Press Y to save the changes and exit from System Setup.
The computer reboots.

Enhanced Pre-Boot System Assessment (ePSA) diagnostics

The ePSA diagnostics (also known as system diagnostics) performs a complete check of your hardware. The ePSA is embedded with the BIOS and is launched by the BIOS internally. The embedded system diagnostics provides a set of options for particular devices or device groups allowing you to:

- Run tests automatically or in an interactive mode
- Repeat tests
- Display or save test results
- Run thorough tests to introduce additional test options to provide extra information about the failed device(s)
- View status messages that inform you if tests are completed successfully
- View error messages that inform you of problems encountered during testing



CAUTION: Use the system diagnostics to test only your computer. Using this program with other computers may cause invalid results or error messages.



NOTE: Some tests for specific devices require user interaction. Always ensure that you are present at the computer terminal when the diagnostic tests are performed.

Running the ePSA diagnostics

1. Power-on the computer.
2. As the computer boots, press the F12 key as the Dell logo appears.
3. On the boot menu screen, select the **Diagnostics** option.
The **Enhanced Pre-boot System Assessment** window is displayed, listing all devices detected in the computer. The diagnostics starts running the tests on all the detected devices.
4. To run a diagnostic test on a specific device, press Esc and click **Yes** to stop the diagnostic test.
5. Select the device from the left pane and click **Run Tests**.
6. If there are any issues, error codes are displayed.
Note the error code and contact Dell.

Technical specifications

 **NOTE:** Offerings may vary by region. For more information regarding the configuration of your computer in:

- Windows 10, click or tap **Start**  → **Settings** → **System** → **About**.
- Windows 7, click **Start** , right-click **My Computer**, and then select **Properties**.

System specifications

Feature	Specification
Chipset	AMD Beema/Carrizo-L
DRAM bus width	64-bit
Flash EPROM	W25Q64FVSSIQ

Processor specifications

Feature	Specification
L2 smart cache	1 MB or 2 MB

Memory specifications

Feature	Specification
Memory capacity	2 GB
Memory type	SO-DIMM DDR3L
Minimum memory	2 GB
Maximum memory	8 GB

Audio specifications

Feature	Specification
Types	High-definition audio codec

Feature	Specification
Controller	Realtek ACL3234
Internal microphone supports	Digital microphone x 1
Speakers	Two 2 watts speaker
External interface	Stereo headset/mic combo
Volume controls	Program menus and keyboard shortcut keys

Video specifications

Feature	Specification
Video type	UMA
Video Controller	AMD Radeon Graphics
Data bus	64 bit
External display support	VGA

Camera specifications

Feature	Specification
Camera Resolution	1 Megapixel
Video Resolution (maximum)	1280 x 720 pixels
Diagonal viewing angle	74 degree

Communication specifications

Features	Specification
Network adapter	Ethernet 10/100/1000 Base-T
Wireless	Wi-fi 802.11 a/b/g/n

Port and connector specifications

Feature	Specification
Audio	combo jack
Video	VGA

Feature	Specification
Network adapter	One RJ-45 connector
USB	One USB3.0, Two USB2.0
Memory card reader	SD card

Display specifications

Feature	Specification
Type	HD
Height	359.60 mm (14.15 inches)
Width	224.40 mm (8.83 inches)
Diagonal	15.0 mm (0.59 inch)
Active area (X/Y)	344.23 mm (13.55 inches) x 193.54 mm (7.61 inches)
Maximum resolution	1366 x 768 pixels
Maximum brightness	200 nits
Operating angle	135 degree
Refresh rate	60 Hz/40 Hz
Maximum viewing angles (horizontal)	40 (L)/40 (R)
Maximum viewing angles (vertical)	10 (up)/30 (down)
Pixel pitch	0.2265 mm x 0.2265 mm

Keyboard specifications

Feature	Specification
Number of keys	80

Touchpad specifications

Feature	Specification
Active Area:	
X-axis	105.00 mm (4.13 inches)
Y-axis	65.00 mm (2.55 inches)

Battery specifications

Feature	Specification
Type	ICP666480
Depth	7.5 mm (0.30 inch)
Height	99.5 mm (3.91 inches)
Width	198.5 mm (7.81 inches)
Weight	269 grams (0.60 lb)
Charge time	3 hour
Life span	300 discharge/charge cycles
Voltage	11.4 V
Temperature range	
Operating	0°C to 50°C
Non-operating	0°C to 65°C
Coin cell battery	LI 3V 83 MAH

AC Adapter specifications

Feature	Specification
Type	45 W
Input voltage	100 ~ 240 V AC
Input current (maximum)	1.3 A
Input frequency	50 Hz to 60 Hz
Output current	2.31 A
Rated output voltage	19.5 V DC
Temperature range (Operating)	0 °C to 40 °C
Temperature range (Non-Operating)	95 °C

Physical specifications

Feature	Specification
Height	23.65 mm (0.93 inches)

Feature	Specification
Width	380.0 mm (14.96 inches)
Depth	260.3 mm (10.24 inches)
Weight	2.45 kg (5.29 lb)

Environmental specifications

Temperature Specifications

Operating	0°C to 35°C
Storage	-20 °C to 60 °C

Relative humidity (maximum) Specifications

Operating	20% to 90% (non condensing)
Storage	20% to 95%(non condensing)

Altitude (maximum) Specifications

Operating	-15.2 m to 3048 m (-50 to 10,000 ft) 0° to 35°C
Non-operating	-15.2 m to 10,668 m (-50 ft to 35,000 ft)

Airborne contaminant level	G1 as defined by ISA-71.04-1985
-----------------------------------	---------------------------------

Contacting Dell

 **NOTE:** If you do not have an active Internet connection, you can find contact information on your purchase invoice, packing slip, bill, or Dell product catalog.

Dell provides several online and telephone-based support and service options. Availability varies by country and product, and some services may not be available in your area. To contact Dell for sales, technical support, or customer service issues:

1. Go to **dell.com/support**.
2. Select your support category.
3. Verify your country or region in the **Choose a Country/Region** drop-down list at the bottom of the page.
4. Select the appropriate service or support link based on your need.